

Instruction Manual



ANDERSON-NEGELE

Anderson Instrument Co., Inc.
156 Auriesville Rd.
Fultonville, NY 12072

Phone: 800-833-0081

www.anderson-negele.com



AV-9900 Microprocesor Based HTST Recorder/Controller

Rev. 3.0

Doc. 1029

1. General Information

1.1. How to Use This Service Manual

In order to facilitate easier start-up and commissioning, the AV-9900 has been pre-programmed at the factory. Before attempting installation, changes, or additions to the unit it is recommended that this manual be thoroughly reviewed. Many common operations have been thoroughly outlined in the Quick Start - How To section. For more detailed explanations of commands, the Menu Options and Setup section provides command options and descriptions.

Chapter 1	Description	Features
Chapter 2	Unpacking	Wiring
Chapter 3	Operation	
Chapter 4	Shortcuts	
Chapter 5	Function Setup Menu - programming	
Chapter 6	Controller Setup Menu - programming	
Chapter 7	Configuration Menu - programming	
Chapter 8	Test routines	
Chapter 9	Calibration routines	
Chapter 10	Model and Revision info	
Chapter 11	Chart Operation	
Appendix I	Warranty	

 **NOTE:** The service manual contains notes that point out key information. When reviewing a section, be sure to stop and review all notes.

 **CAUTION:** The caution symbol will alert the user/installer to functional or safety hazards which may effect the operation of the equipment, or create a safety hazard for the individual. Be sure to read each of these notations.

For additional service/set-up questions you may call your authorized Anderson Distributor. In addition, you may reach Anderson Technical Services directly at the following numbers:

Phone: 518-922-5315 or 800-833-0081

Fax: 518-922-8997 or 800-726-6733

1.2. AV-9900 Description

The AV-9900 High Temperature Short Time Controller provides all USPHS required functions associated with recording pasteurized product temperature, signaling the flow diversion valve (F.D.V.), and recording the Flow Diversion Valve position. Addition features allow for multiple diversion set-points, recording active setpoint, cold product recording - with optional control, and hot water control.

1.3. AV-9900 Features

1.3.1. Hot Product Temperature Sensor

The Hot Product Sensor is a dual element, 1000ohm Resistance Temperature Detector (RTD). The Primary RTD supplies the recording - thermal limit signal input, with the Secondary RTD supplying a verification signal.

Sensors are available with a wide variety of sanitary connections featuring a 5-1/2" or 7-1/4" probe length. Provision for the *Health Authority Seal* on the stainless steel conduit housing provides separate servicing of the probe, and ease of installation. Overall response characteristics allow for cable runs of up to 500 feet.

Chart ranges are programmable, and are factory set to meet all Pasteurized Milk Ordinance (PMO) requirements. In addition, criteria of 12 hour rotation, linear, and 1⁰F divisions have been met.

1.3.2. Diversion Switching

Diversion set-point circuitry provides for up to five selectable cut-in/cut-out temperatures. User configurable parameters exist for displaying the active set-point. The current set-point is recorded to the chart for verification at time of cut-in. Diversion set-point values are easily modifiable upon breaking the Health Authority Seal, and entering the system program mode. In addition to restricting access to the Run/Program shunt jumper, the chart plate seal prevents modifications to circuit boards and input/output wiring connections.

Flow Diversion Valve position is indicated by red and green lights on the chart plate, in addition to being recorded by an event pen on the outside area of the chart. The event pen position is outward for forward flow on all diversion set-points. Selection of the current diversion set-point is accomplished via the front mounted user keypad and display. Five function keys become active, allowing the user to choose the desired set-point.

1.3.3. Diagnostic Circuitry

The AV-9900 provides fail-safe operation via internal self-diagnostics of the Hot Product Probe input signals. The Primary RTD input signal is continually referenced against the Secondary RTD signal. The result is indicated on a series of LED's, located just above the user display, and labeled *Sensor Balance*. If both RTD elements are in agreement by less than .5⁰F, no LED's are lit. Each increment of .5⁰F error will light an LED. At the point at which the elements differ greater than 2⁰F, the AV-9900 will go into automatic divert. In addition, the user display will indicate that a *Probe Failure* has taken place. Until a replacement Hot Product Probe is installed, the unit will not allow a forward flow condition to take place.

1.3.4. Pen Drive Mechanism and Chart Printing

The pen drive mechanism is similar to a dot-matrix print device in that a series of dots are placed down onto the paper chart. This mechanism is fully alpha-numeric capable allowing printing of ranges, units, alarm's, etc. to the chart. All four pens are housed with a small pen cartridge in a straight line arrangement. As a result, all data printed to the chart is on the same time line. No lag exists from pen to

pen as with typical felt pen type recorders. Chart ranges and scales are factory programmed, per applicable PMO requirements, but may easily be re-ranged in the field. Charts are plain paper, and pre-printed only with circular ring divisions. Division spacing meets PMO requirements. User defined scales and chart ranges are printed in one of four available colors.

1.3.5. Cold Product Record - Control

The AV-9900 may be configured to receive an input from an RTD, or mA transmitter, measuring the Cold Product temperature as it exits the pasteurization loop. This function may be specified at time of order, or upgraded in the field at a later date. A factory set, field modifiable scale has been programmed for the recording pen. Data will be recorded in color allowing easy interpretation when reviewing chart information.

An additional option exists for controlling the Cold Product Cooling within the AV-9900. An optional PID Loop Control function can be specified at time of order, or upgraded at a later date in the field. This function will receive its input from the same probe measuring the Cold Product temperature. In turn, a desired set-point may be programmed, with output signals interfacing to the cooling loop. The PID, or control functions, will vary the resulting output signal based on rising above or falling below the desired Cold Product set-point.

1.3.6. Hot Water Loop Control

The AV-9900 may be configured to receive an input from an RTD, or mA transmitter, measuring the Hot Water Loop temperature. This function may be specified at time of order, or upgraded in the field at a later date. In turn, a desired set-point may be programmed, with output signals interfacing to the Hot Water Loop. The PID, or control functions, will vary the resulting output signal based on rising above or falling below the desired Hot Water set-point.

If various products are being processed, up to five Hot Water Controllers are available (one for each STLR diversion set-point). Each controller may have it's own set-point and PID tuning parameters. When the operator selects a new STLR diversion set-point, the corresponding Hot Water Controller is automatically selected. Again, Hot Water Control set-points and PID tuning parameters would have been pre-programmed

1.3.7. Safety Flow Limit Record - Control

The AV-9900 may be configured to receive an input from a Sanitary Flow Meter for the purpose of controlling the pasteurization loop flow rate via Meter Based Timing. This function may be specified at time of order, or upgraded in the field at a later date. A factory set scale has been programmed for the recording pen per FDA (Food & Drug Administration) guidelines. Data will be recorded in color allowing easy interpretation when reviewing chart information. In addition to the recorded flow rate on the chart, an event pen is also present on the outer chart area. This event pen indicates when the system has gone below "Loss of Signal" setpoint, "High Flow" setpoint or is in proper flow. These alarm conditions directly switch on-board mechanical relays. Contacts of the relays interface with the Legal Flow Control unit, allowing for auto system divert in the event of an alarm condition.

An optional PID Loop Control function can be specified at time of order, or upgraded at a later date in the field. This function will receive its input from the same flow meter signal feeding the recording pen. In turn, a desired set-point may be programmed, with output signals interfacing to the pump controlling the system flow rate. The PID, or control functions, will vary the resulting output signal based on rising above or falling below the desired Flow Rate set-point.

2. Installation

The following section details mounting, installation, and wiring details for the AV-9900 Series HTST Controller.

⚠ CAUTION: Be sure to thoroughly read the material in this section prior to installation. Data tags for voltage and wiring are located inside the unit, viewable upon swinging the chart plate forward.

2.1. Unpacking

Remove the instrument and pen cartridge assembly from the shipping container and inspect for any damage due to transit. If damage has occurred, report and file a claim with the carrier immediately. All packing and shipping materials should be secured as proof of damage.

🎵 NOTE: Charts, pen cartridge, and included service manual are enclosed in a cardboard box within the container holding the unit. Be sure to secure these items before discarding shipping material.

Select a location for the instrument which is accessible, clean, well lighted and free from excessive vibrations and wide variations in temperature. The instrument should be mounted vertically on a rigid support (either wall mount or panel mount). Be sure to observe all local wiring codes.

2.2. Mounting

Wall Mount: Brackets supplied provide holes for 1/4" machine bolts or No. 14 wood screws.

Panel Mount: Four countersunk locations provided for 1/4" machine bolts. Accessible by swinging open door and chart plate - located on upper and lower lip of case. Installer required to complete hole penetration through case

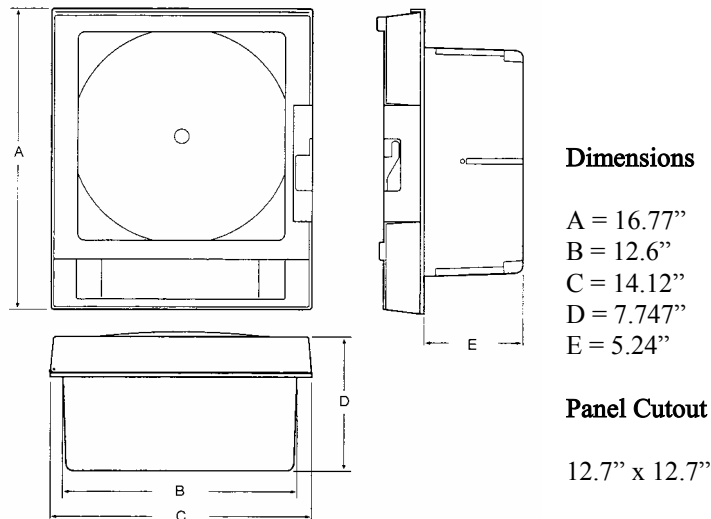

Figure 1 - Case Dimensions

2.3. Circuit Board Identification / Locations

The following diagram shows the locations of circuit boards within the AV-9900. Case cutouts have been provided for wire entry, and are located at the base of the unit. In order to eliminate interference, be sure to isolate signal cables from power cables when entering recorder.

⚠ CAUTION: To prevent moisture entry, or damage to components, DO NOT cut case penetrations in sides or top of unit.

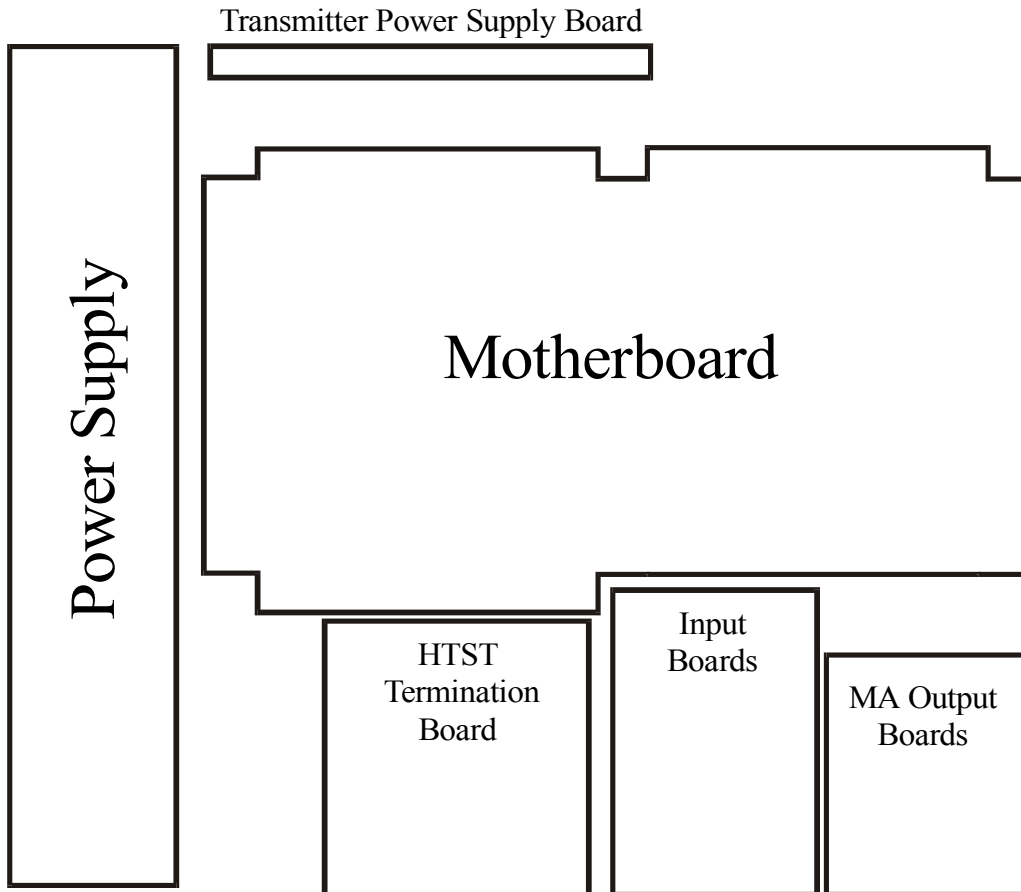

Figure 2 - Board Layout

Note: Boards present will be determined by model ordered.

2.4. AC Power Wiring

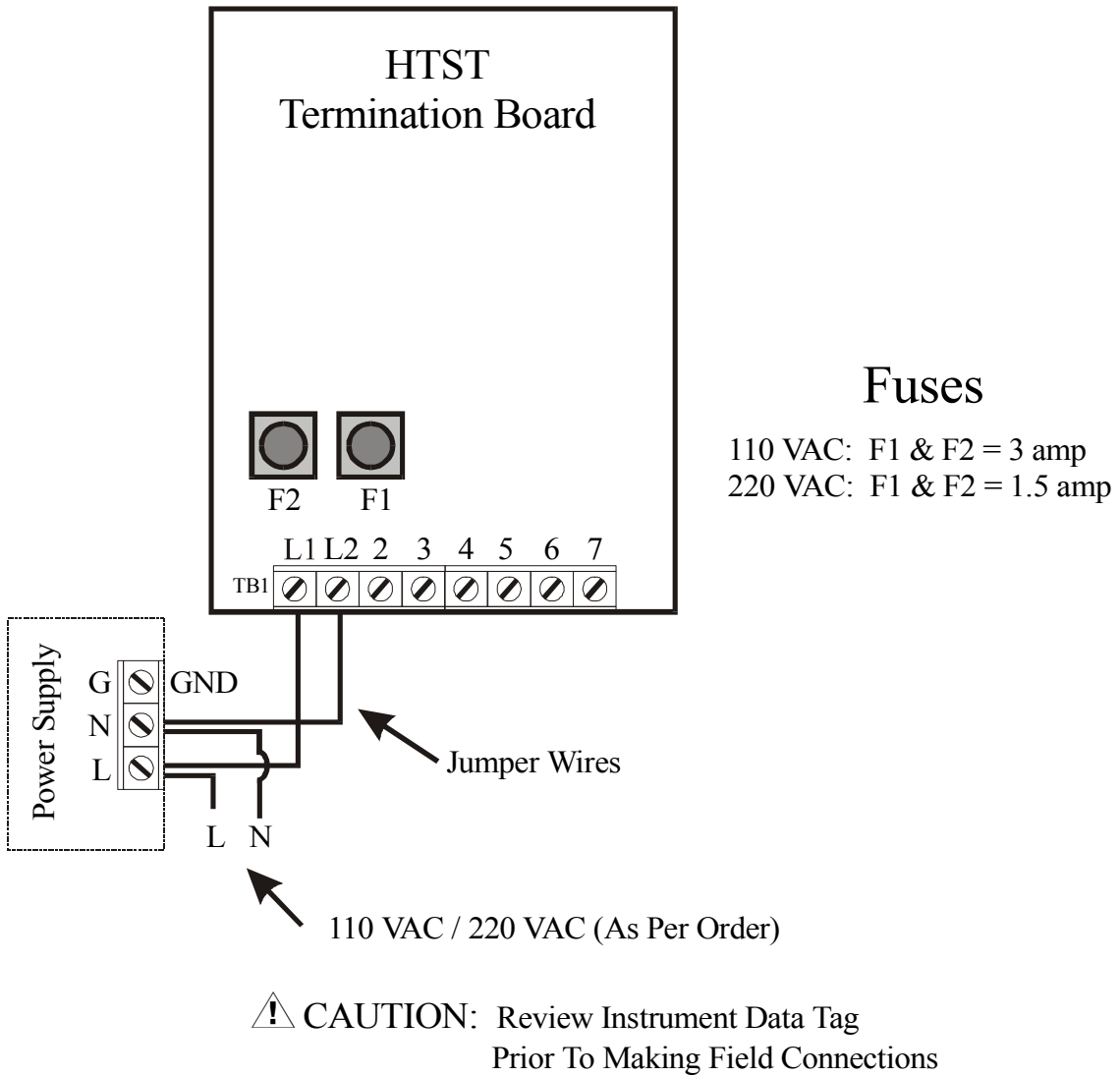

Figure 3 - Power Wiring

2.5. Signal Input and Output Wiring

The following sections illustrate wiring connections for the signal inputs and outputs. Prior to performing termination's, be sure to review each section as installed components will vary based on the configuration ordered.

CAUTION: Disconnect power to the instrument to prevent electrical shock or component damage.

2.5.1. Legal Controls Wiring

Wiring to the legal controls (FDV, Differential Pressure Switch, etc.) is accomplished on the HTST Termination Board. The terminal strip wiring utilizes the conventional HTST numbering system for ease of setup.

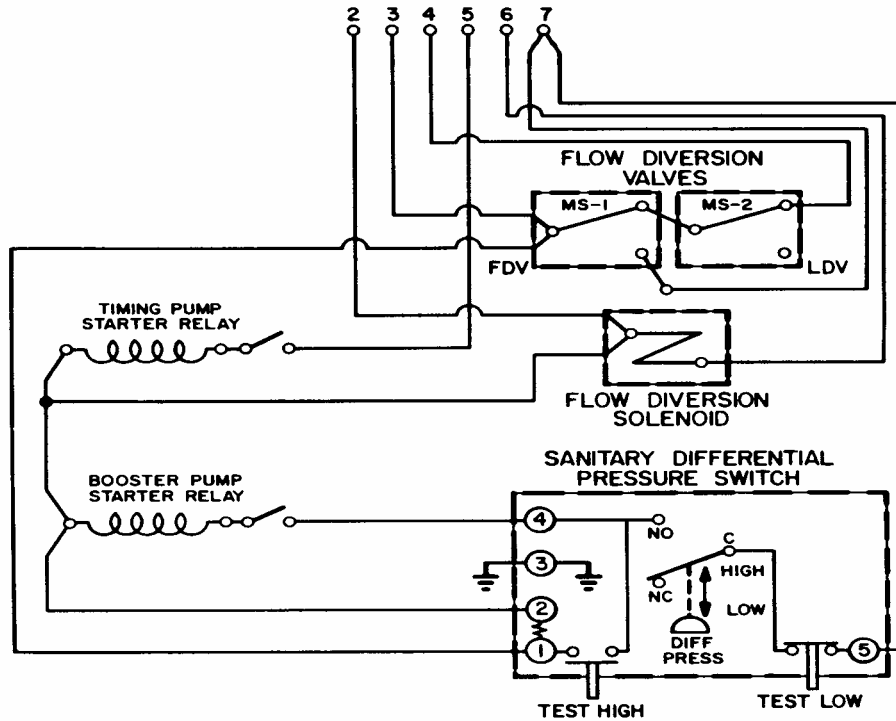

Figure 4 - Legal Field Wiring

2.5.2. Input Card General Information

The first step in making wiring termination's is to identify the functions that are present within the unit. The data tag on the inside of the unit will show the *Matrix Order Number*. A complete product matrix, showing all options, has been supplied under the Specifications section of this manual. Once functions that are present have been identified, the following sections will guide the installer through wiring connections and termination's.

STLR Function	Always present
Hot Water Function	First available option
Cold Product Function	Second available option
SFLR Function	Third available option

Depending on the features ordered there will be either One, Two, or Three stacked input cards. Unless specified at time of order, all programming and jumper selections have been pre-set at the factory.

Note: The following chart outlines board locations for *Input's* only.

Board Location	LEFT Input Channel	RIGHT Input Channel
First (Furthest In)	Hot Product / Input 1 (ALWAYS - Cannot change)	Hot Product / Input 2 (ALWAYS - Cannot change)
Second (Stacked on top of first)	Input 3 (mA or RTD)	Input 4 (mA or RTD)
Third (Stacked on top of second)	Input 5 (mA or RTD)	Not present

Each input card has a set of jumpers which determine the location within the instrument (Board one, two, or three). For ease of wiring, it may be necessary to remove cards. Locating JU13 and JU14, near the top of each card, will indicate which position they should be re-installed into the unit.

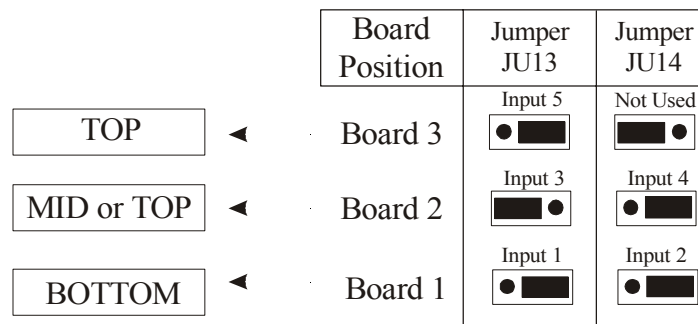

Figure 5 - Input Card Details

2.5.3. Hot Product Probe Input Board Wiring

The Hot Product Probe will always terminate at the bottom (furthest in) input card. The wiring terminal block of this board has been color coded so as to differentiate it from the remaining cards. Termination's to the Hot Product Probe are as follows:

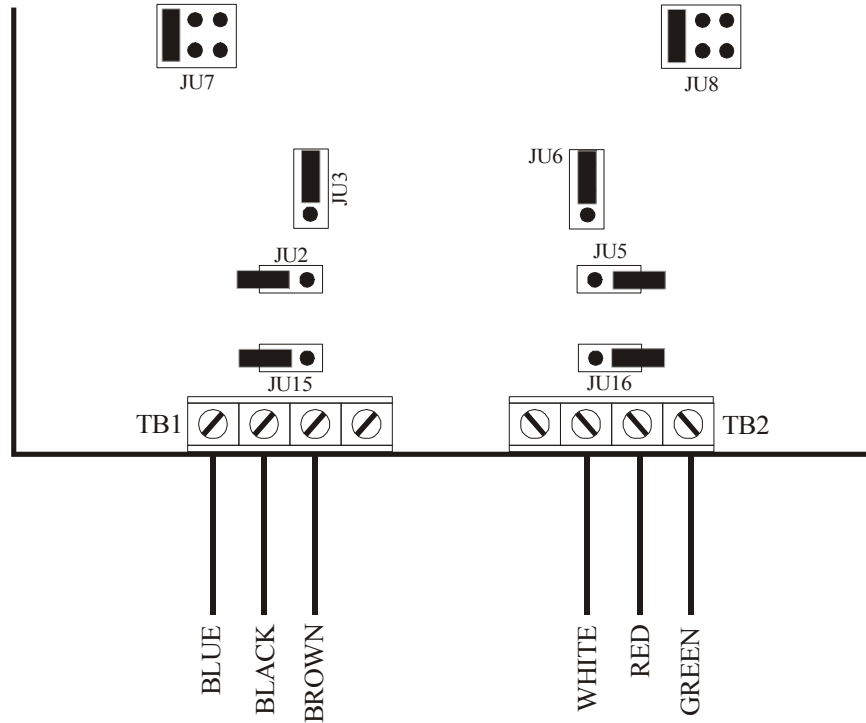

Figure 6 - Hot Product Input Card Wiring

All conditioning jumpers have been pre-set at the factory. Proper positions have been noted on the above diagram.

2.5.4. Hot Product Probe Wiring

The Hot Product Sensor is provided with dual removable plugs and a specified amount of six conductor shielded cable. If wires are removed for installation purposes, they must be re-wired properly.

CAUTION: Anderson does not recommend splicing of signal cable. The possibility will exist for corrosion, leading to intermittent connection or loss of signal. If cable length is insufficient, it is recommended that a new, longer, cable be utilized.

VIBRATION DAMPENER - DO NOT DISCARD: A small black rubber puck was shipped with the Hot Product Probe. It is inside the conduit housing of the sensor, and must be removed for wiring. This puck prevents terminal blocks from coming loose in high vibration applications. RE-INSTALL upon completion of probe wiring.

Once all wiring has been completed, a *Health Authority Seal* must be placed from the cap (hole provided) around the seal-tight grommet. This will prevent unauthorized entry into the Hot Product Probe.

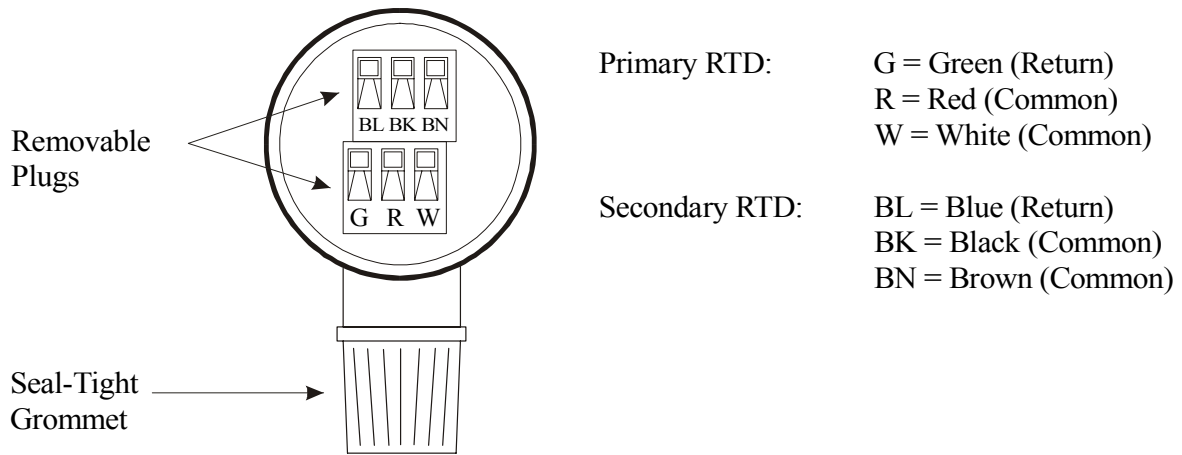

Figure 7 - Hot Product Probe Wiring

2.5.5. RTD Input Board Wiring

Each half (right or left) of the remaining input cards may be set for either RTD or mA inputs. You should first determine which input you will be working with (Cold Product or Hot Water), it's type (RTD or mA), and finally which terminal it wires to. The following diagram illustrates the wiring and configuration jumper positions for both an RTD wired to the LEFT or RIGHT of an input card.

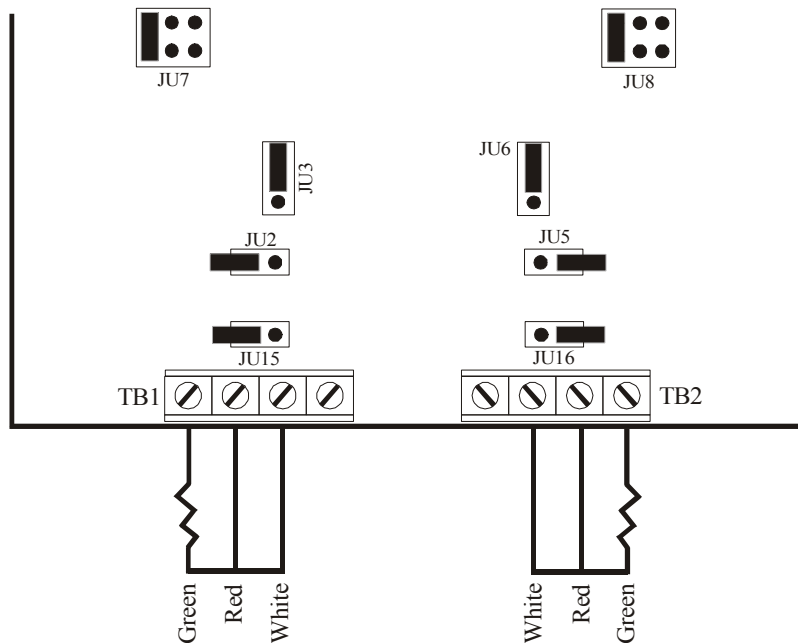

Figure 8 - RTD Input Card Wiring

All conditioning jumpers have been pre-set at the factory. Proper positions have been noted on the above diagram.

2.5.6. mA Input Board Wiring

Each half (right or left) of the remaining input cards may be set for either RTD or mA inputs. You should first determine which input you will be working with (Cold Product or Hot Water), it's type (RTD or mA), and finally which terminal it wires to. The following diagram illustrates the wiring and configuration jumper positions for both a 4-20 mA input wired to the LEFT or RIGHT of an input card.

NOTE: Before completing wiring, determine whether mA input from sensor is Powered or Un-powered. This can be accomplished by placing a meter (DC Volts position) across the two sensor leads. If a voltage is observed, the signal is said to be Powered. Wiring can go directly to the mA input of the associated card. If NO voltage is present, a loop power supply must be utilized. If AV-9900 ordered with Transmitter Power Supply option, refer to next section for wiring. If external, customer supplied, power supply to be utilized, final wiring termination's will be as follows:

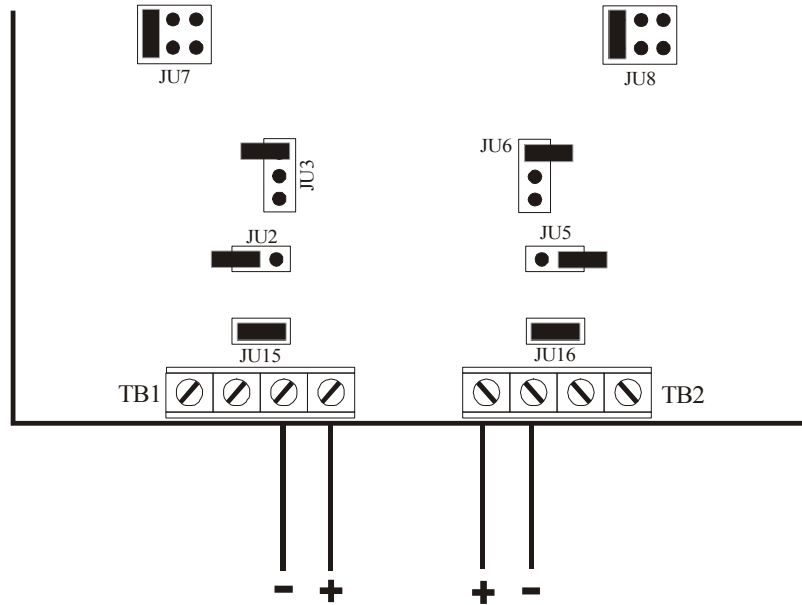

Figure 9 - mA Input Card Wiring

All conditioning jumpers have been pre-set at the factory. Proper positions have been noted on the above diagram.

2.5.7. Transmitter Power Supply Wiring

If supplied with the transmitter power supply option, connections will be located near top of unit. Refer to the circuit board locations diagram for assistance in locating the board. Wiring connections to a transmitter will be as follows:

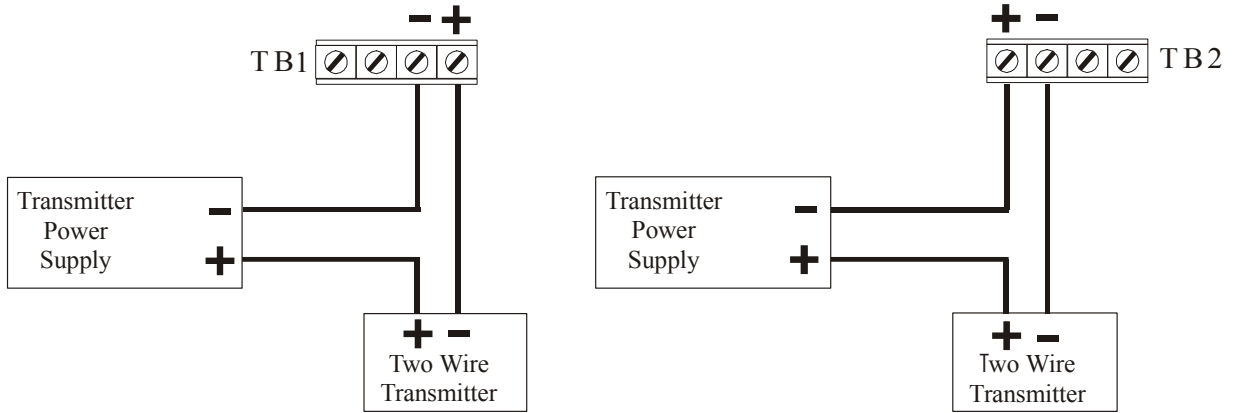

Figure 10 - Transmitter Power Supply Wiring

2.5.8. mA Retransmission Output Board Wiring

Refer to the circuit board locations diagram for assistance in locating the mA retransmission board. Retransmission signals are utilized as outputs from either the Cold Product PID Loop Controller or the Hot Water Loop Controller. They are powered signals, with wiring as follows:

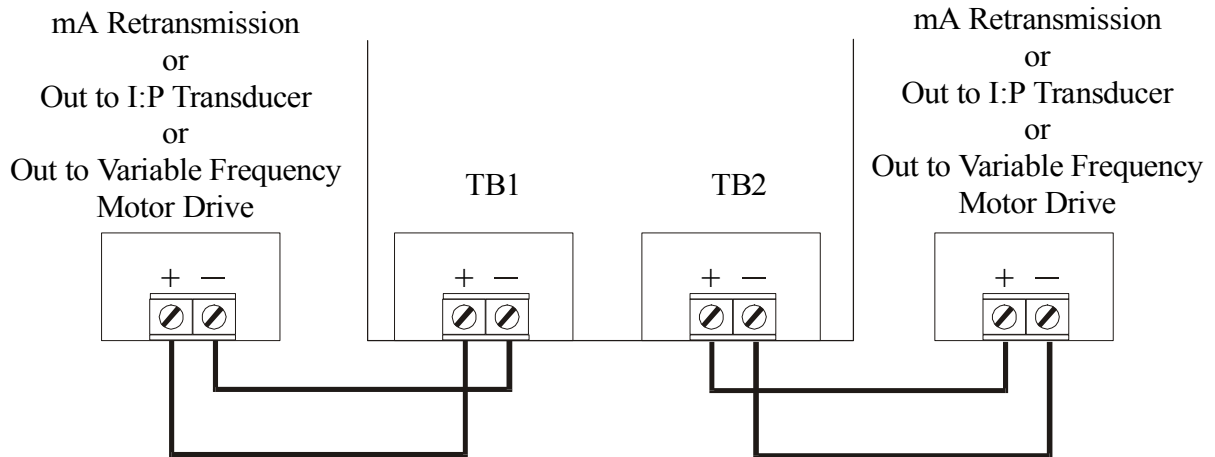

Figure 11 - mA Retransmission Output Wiring

2.6. Relay Output Wiring

Refer to the circuit board locations diagram for assistance in locating the relay board. Wiring is as follows:

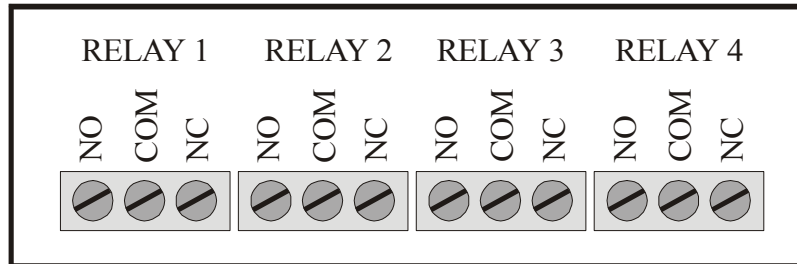

Figure 12 - Relay Board

NOTE: If ordered with **Safety Flow Limit Record** function, Relay 1 and Relay 2 will be pre-configured to act as the flow alarms. Details are as follows:

- Relay 1 = SFLR Alarm 1 = “Loss of Signal” alarm
 - Wire to COM and NO terminals for failsafe operation
- Relay 2 = SFLR Alarm 2 = “High Flow” alarm
 - Wire to COM and NO terminals for failsafe operation

Relay contacts interface with Legal Flow Control unit found in system. For proper operation, these relays **MUST** be utilized. Proper system function is not possible utilizing external “Loss of Signal” and “High Flow” relays.

2.7. Chart Plate Health Authority Seal

A through hole lug and post have been provided for installing the Health Authority Seal. They are located in the upper right corner of the chart plate.

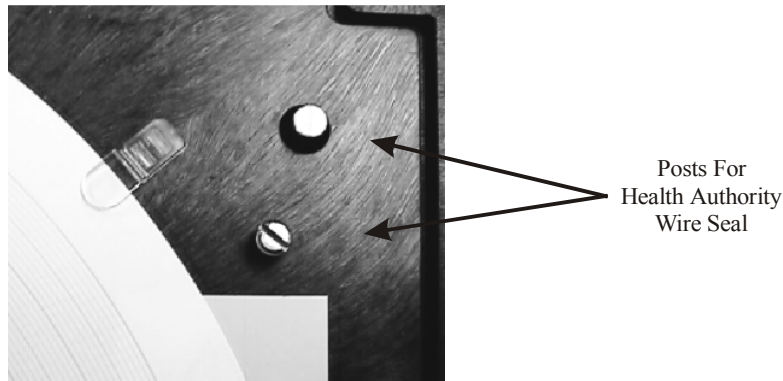

Figure 12 - Health Authority Seal

3. Instrument Operation

The AV-9900 is a fully microprocessor driven instrument, and possesses many options for customizing operation and output. This section will detail specifics relating to overall operation of the unit.

3.1. Installation of pen cartridge assembly

Remove the pen cartridge assembly from its shipping container. With mounting tab on the bottom, slide the pen cartridge assembly (item #2) into the print actuator (item #1).

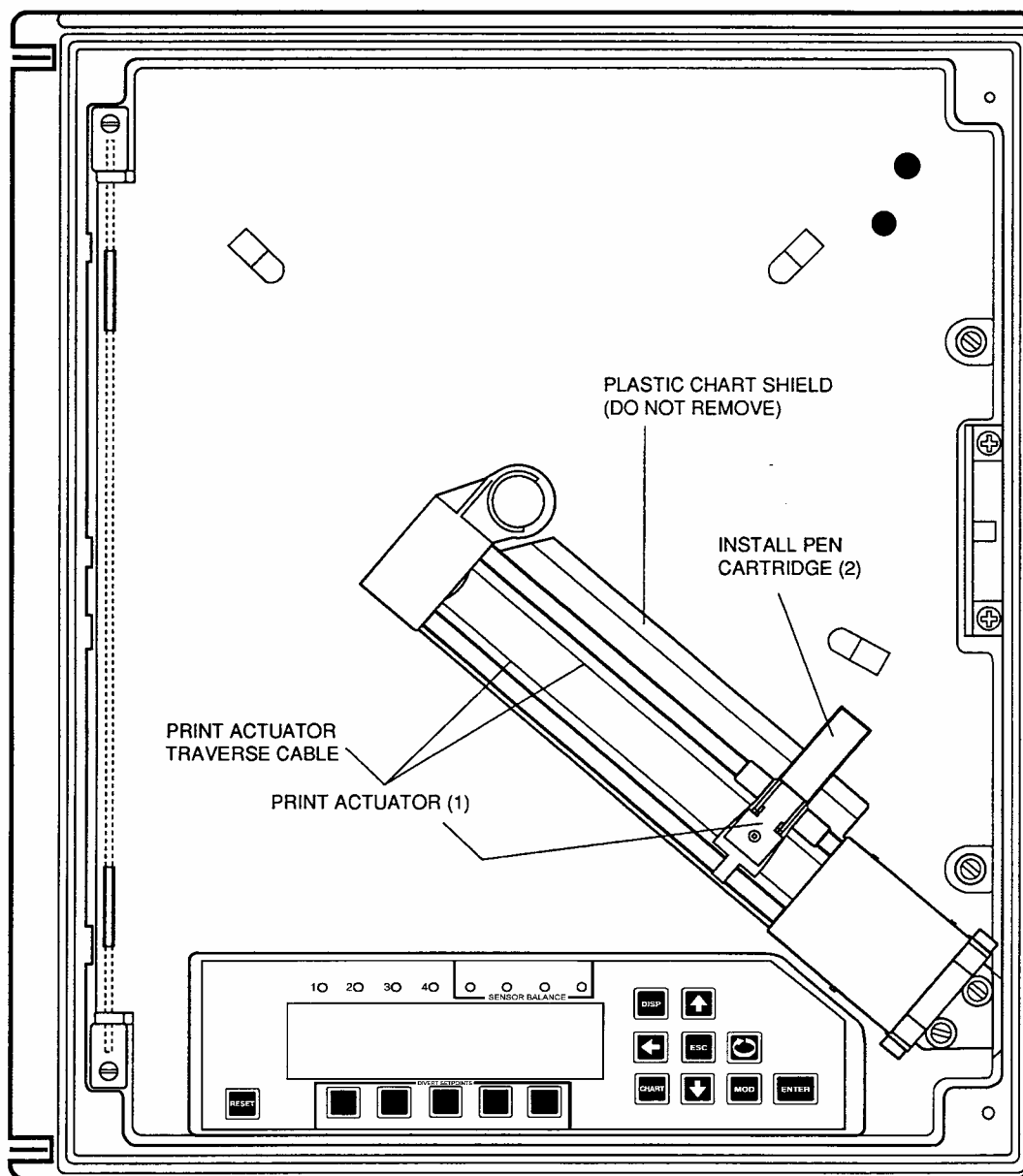

Figure 1 - View of Chart Plate

3.2. Recording Chart Identification



STOP: The AV-9900 uses only one style chart. Be sure Chart Number **00215401** is being utilized. HTST ONLY is printed around the center hub for ease of identification.

Charts are installed by simply loosening the knurled lug located at the end of the print arm assembly. This will allow the entire assembly to swing forward. The chart may then be installed, taking care to slip edges underneath the plastic retainer clips. Swing the pen arm assembly closed, and tighten the knurled lug.

3.3. Keypad

Located on the front chart plate of the unit is the USER KEYPAD. From here, access to the program parameters can be gained. A description of each of the keys is as follows:



Up Arrow Key: Used to move through menus, or increase a value



Down Arrow Key: Used to move through menus, or decrease a value



Left Arrow Key: Used to move through menus or digits of a parameter



Scroll (Right Arrow) Key: Used to move through menus or digits of a parameter



Escape Key: Used to cancel a flashing program prompt



Reset Key: Will jump from within programming menus to the standard operating display



Display Key: Allows access to display menu options, STLR setpoints and additional menus as activated



Modify Key: Allows changes to be made to a currently displayed parameter



Chart Key: Allows access to the Change Chart Routines (Run mode) and Chart parameters (Program mode)



Enter Key: Locks in changes made to a parameter

3.4. User Display

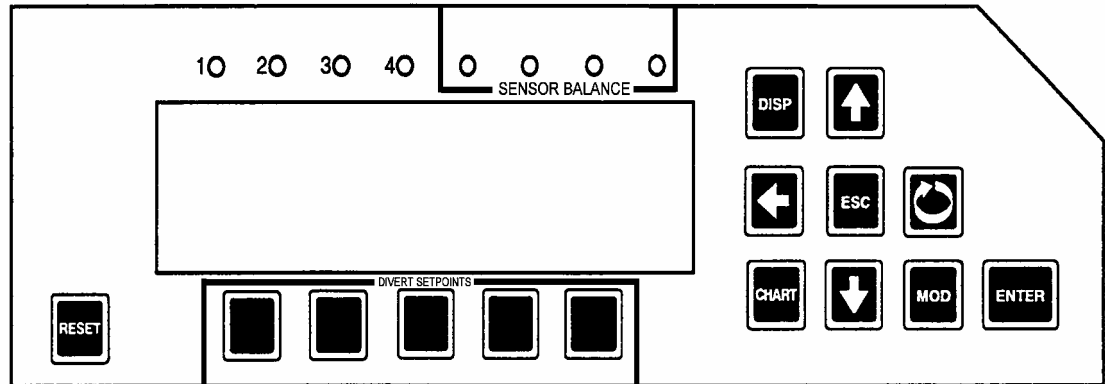













Figure 2 - Keypad / Display











Also located on the front chart plate is the User Display. From here, data such as a digital readout of the STLR temperature value may be viewed.

Two options exist for the display; CONTINUOUS DISPLAY and SEQUENCE DISPLAY. When in continuous mode, the selected parameter is viewable at all times on the display. This is the required mode for completion of the Appendix I Pasteurized Milk Ordinance testing. While in sequence mode, various parameters scroll over the screen at a timed interval.

3.4.1. Display - Continuous Mode

1. Operation may be done with Security Mode Shunt in either position - no changes required.
2.   key twice - you will see: **MODIFY** <->
DISPLAY PARAMETERS
3.   key once.
4. If CONTINUOUS is not already flashing,   key.
5. With CONTINUOUS flashing,   key once.
6.   key once to return to the main display.
7.   until STLR INP is displayed - this is the digital display of Hot Product Temperature.

3.4.2. Display - Sequence Mode

1. Operation may be done with Security Mode Shunt in either position - no changes required.
2.   key twice - you will see: **MODIFY** <->
DISPLAY PARAMETERS
3.   key once.
4. If SEQUENCE is not already flashing,   key.
5. With SEQUENCE flashing,   key once.
6.   key once to return to the main display.

3.4.3. Sensor Balance LED's

Located directly above the blue user feedback display are the Sensor Balance LED's. The Anderson Hot Product Temperature probe utilized for the STLR input contains two resistance temperature detector elements. These elements provide the temperature input to the STLR portion of the system. A continuous check is made between the two elements.

Match to < .5 °F shift	=	No LED's lit - operation allowed
>= .5 °F to < 1 °F shift	=	1 LED lit - Forward Flow allowed
>= 1 °F to < 1.5 °F shift	=	2 LED's lit - Forward Flow allowed
>= 1.5 °F to < 2 °F shift	=	3 LED's lit - Forward Flow allowed
>= 2 °F shift	=	4 LED's lit - NO Forward Flow allowed

Display shows:

*** WARNING ***
SENSOR BALANCE FAILURE

Possible causes for a sensor balance failure are:

- Shorted elements - failed probe
- Broken / unattached wires

The **Sensor Balance Failure** display will be shown until the error condition is rectified. Even if proper temperatures are met, the unit will send a signal to the Flow Diversion valves to authorize forward flow.

3.5. Changing Parameters

There are three types of parameters in the AV-9900:









Values = Numeric values

Text Strings = Groups of characters





Choices = Selections made by picking one of a group of displayed descriptions













With a modifiable parameter description and its setting displayed, pressing the MOD key places the unit in MODIFY where the settings may be altered.















3.5.1. Changing Values

If the setting is a value (number), the cursor will be positioned on the right-most digit. The  and  keys will move the cursor left or right. The   keys will increment or decrement the value with rollover and rollunder through all digits to the left of the cursor.   key exits Modify, no change being made to the original value.   key exits Modify, with the new value being displayed and entered into memory.











3.5.2. Changing Text

There are two ways to modify text. The first, Character Modify, is accessed by the initial pressing of the  key, and the second, Character Selection, is accessed by pressing the  again. Pressing the  key after pressing the  key will clear all characters from the cursor to the right.



- If the setting is text (Ex. units, tag, etc.), the text will be left justified and the cursor will be positioned on the left most character. The  and  keys will move the cursor left or right.
- In Character Modify, the  and  keys change the character by scrolling through a list or string of available characters. The  and  keys will move the cursor left and right to allow changing another character.   key enters Character Selection.   key exits Modify, no change being made to the string.   key exits Modify, with the new string displayed and entered into memory.

- In Character Selection,    will initiate Character Selection. The character to be changed (on the lower line) will be replaced by the “block” character (all dots lit), and the upper display line will show a character selection line instead of the parameter description. The character selection line which contains the current character will be displayed with the cursor positioned on the current character. The  and  keys will move the cursor left and right on the current character selection line. The  and  keys will change the line of characters displayed for selection. Once the cursor is positioned on the desired character,   key will store the desired character in the lower line, the ‘block’ character will move to the next position on the second line, and the character selection line which contains the next character will be displayed with the cursor positioned on that character.
- While in Character Selection,   key exits Character Selection and return the unit to Character Modify where selection of another character may be made, or   again exits Modify.
- While in Character Selection,   key after modifying a character will exit Character Selection and the new string will be displayed and entered into memory.

3.5.3. Changing Choices

- If the setting is a YES/NO choice, the YES/NO choice line will be displayed and the current choice will blink. The   keys will switch the selection between YES and NO. Selecting the choice and   will exit Modify, with the string displayed and entered into memory. Some YES/NO parameter choices are initialized to NO. When changing to YES, the unit may automatically advance to the next parameter upon  .
- If the setting is one of a list of choices, the choice line containing the current choice will be displayed and the current choice will blink. If multiple choices are displayed, the  or  keys will move the selection to the left or right. If all choices are not displayed at once, due to multiple choice lines, the  key will step backward to the previous choice line, or the  key will step forward to the next choice line.

key will step forward to the next choice line.   key exits Modify, no change being

made to the string.   key exits Modify, with the new string displayed and entered into memory.

3.6. Security Mode Selection Shunt

The AV-9900 is equipped with a movable shunt to allow toggling between RUN and PROGRAM modes of operation. While in RUN mode, access is prevented to all system critical parameters (ranges, setpoint changes, etc.). Changes may be made to display functions as well as selection of the currently active diversion setpoint. While in PROGRAM mode, full access to all system parameters is allowed.

NOTE: Moving the Security Mode Selection Shunt to the PROGRAM position will *immediately* force the unit to DIVERT flow. If already in DIVERT flow, the unit will remain in that mode even if the hot product temperature rises above the active setpoint.

The following diagram illustrates the location of the Security Mode Selection Shunt, in addition to the settings, RUN or PROGRAM.

HTST Termination Board

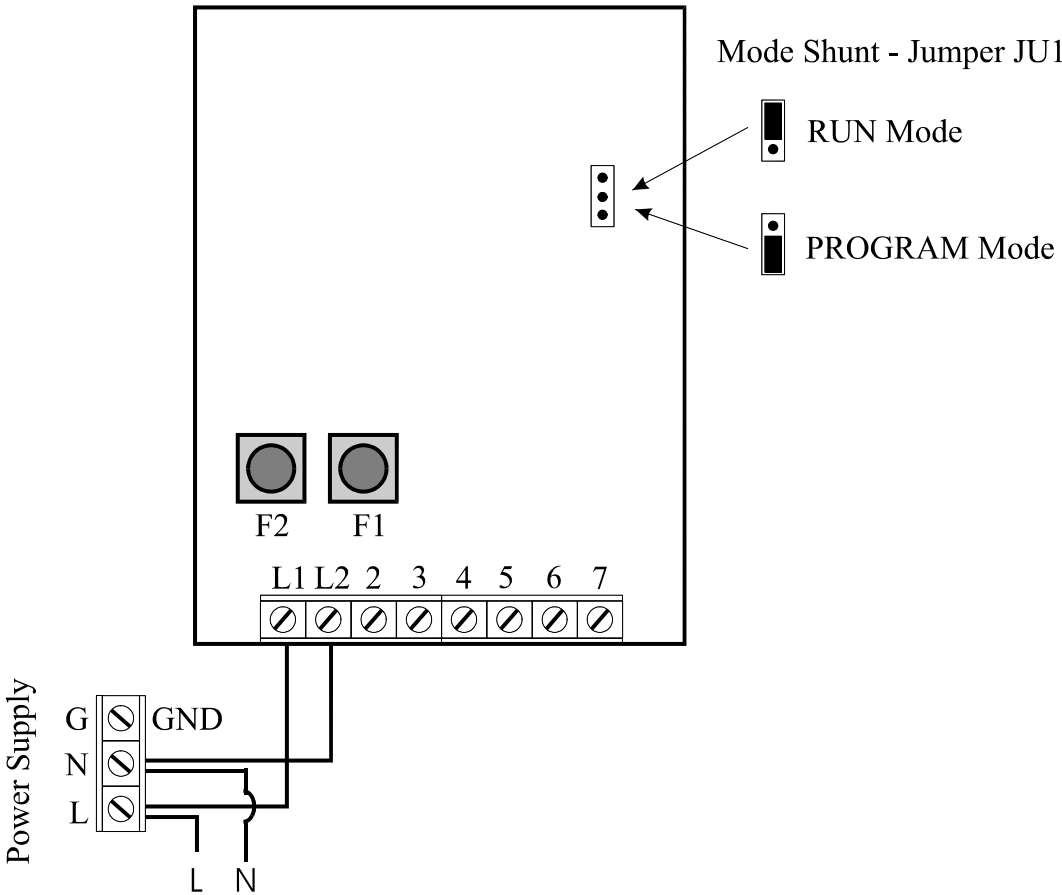

4. Quick Start - How To

The Quick Start - How To section is designed to fully illustrate the most common operations that are performed on the AV-9900. References, where applicable, will also be given to additional areas of coverage throughout the manual.





4.1. How Do I Start and Stop Chart Printing

The AV-9900 differs from traditional circular chart recorders in that a print mechanism not only records data to the chart, but also prints times and chart scales. For this reason, it is necessary to tell the AV-9900 when we want to stop a chart from spinning, or we are ready to start printing a new chart.

 NOTE: The Change Chart Procedure is initiated while the unit is in the RUN mode.





4.1.1. Stop Printing Chart

The **Stop Print** routine is generally used when we have completed a processing run, and wish to remove the chart from the AV-9900. The procedure is as follows:

1.  key to initiate Stop Chart routine
2. Display will show: STOP CHART
 NO YES
3.  YES (Or   to cancel)
4. Chart will stop rotating, unit will move to Divert Flow, NO data collection is active
5. At this point a chart may be removed - the unit may be left in this mode until such time that operation of the process loop is ready to start again. Displays will remain active for temperature verification.

4.1.2. Start Printing New Chart

The **Start Print** routine is generally used when we are ready to **start a new processing run**. A new chart will be started, complete with new scales. As the unit will print scales, time and date information; it is not necessary to record any of that information manually.

1.  key to initiate Start Chart routine
2. Display will show: START NEW CHART
 NO YES
3.  YES (Or   to cancel)

4. Chart will start to print. Scale and time information will begin at top of current hour (Ex. Currently 4:15 pm, chart started, time mark will begin at 4:00 pm).
5. Chart will print at increased speed until real time is achieved. Data, recorded to memory from the time **Start Chart YES** was selected, will be printed to chart.
6. During this period where chart is catching up to realtime, all legal functions are active, and display illustrates current system activity and temperature.

4.1.3. Hold Chart Printing

The **Hold Print** routine is generally used when we are currently in a processing run, but wish to stop the chart so that manual information may be recorded to the chart without interference from the moving print head assembly. The AV-9900 will continue to monitor all legal controls, with the user display remaining in full operation. If a diversion event occurs, legal actions will be initiated, and the event will be recorded to memory. The AV-9900 may remain in the **Hold sequence for up to 5 minutes**. When exiting the Hold sequence, the chart printing will be accelerated until the point where real time has again been reached.



NOTE: Chart HOLD may only be initiated while in RUN mode, and with chart printing in Real Time. The period immediately following a NEW CHART routine, or a CONTINUE CHART routine forces data to the chart at an accelerated, NOT real time mode of recording. You must first wait until real time printing is achieved prior to initiating the Hold.



1.    to initiate the chart Hold sequence
2. Display will show:

CHART ROTATION
CONT HOLD NEW
3.  FUNCTION KEY directly beneath **HOLD**
4. Display will show:

















CHART ROTATION
HOLD
5. The chart is now in a Hold state. All current events are being recorded to memory.
6. Notations may be made to the chart at this time - proceed to step 7 to re-start chart.
7.    to initiate the Chart Continue sequence
8. Display will show:

CHART ROTATION
CONT HOLD NEW
9.  FUNCTION KEY directly beneath **CONT**
10.   to return to normal display
11. Chart will begin printing at an accelerated speed until all data and events have been transferred from memory to the chart, and real time has again been reached.



4.1.4. Change Chart While Processing

1.    to initiate the chart Hold sequence
2. Display will show: CHART ROTATION
 CONT HOLD NEW
3.  FUNCTION KEY directly beneath **HOLD**
4. Display will show: CHART ROTATION
 HOLD
5. The chart is now in a Hold state. All current events are being recorded to memory.
6. Place the NEW BLANK CHART onto the AV-9900 at this time - proceed to step 7 to re-start chart.
7.    to initiate the Chart New sequence
8. Display will show: CHART ROTATION
 CONT HOLD NEW
9.  FUNCTION KEY directly beneath **NEW**
10.   to return to normal display
11. A new chart will begin to print. Data, from the time Chart Hold was initiated, is being recorded to memory. Chart will begin printing at an accelerated speed until all data and events have been transferred from memory to the chart, and real time has again been reached.

4.2. How Do I Change an STL R Diversion Setpoint

Up to five STL R diversion setpoints may be pre-programmed into the AV-9900 (See section 5.4.1). If only one setpoint is programmed (single divert), the option as described below will not apply. Refer to Section 5.4.1 for further information on how to activate additional setpoints.

 NOTE: Choosing an alternate diversion setpoint may be done in either PROGRAM or RUN mode. If performed in Program mode, the change will not take effect until returning the unit to Run mode.

1.   key to activate Diversion Setpoint Select
2. Display will show: **STL R SETPOINT SELECT**
 XXX XXX XXX XXX XXX
3. The current setpoint will be flashing



4.  Function Key directly under desired setpoint value
5. New setpoint will be selected, display will return to normal mode
6. If selected, green pen will move from recording previous setpoint, to recording new diversion setpoint to chart

4.3. How Do I Place a Controller Into Manual / Automatic Mode

 **NOTE:** If changes are present that differ from factory setup, this option may not be active. Consult Anderson Instrument for additional assistance.







The standard operating state for the Cold Product, Hot Water, and Flow controllers is Automatic mode. If desired, to facilitate easier process startup or testing, each of the controllers may be placed into Manual mode. While in Manual, a percentage of output (0-100%) may be directly altered by the user. This change will immediately influence the resulting controller output, remaining at that position until an additional change is made to the Manual Mode Percentage. Bumpless transfer is maintained while switching modes to prevent output spikes.

4.3.1. Toggling Auto/Manual



1. From normal display,   until showing:

XX	CONTROLLER
AUTO	MANUAL

XX = Active controller (CP, HW, or SF)











2. Current output mode, Auto or Manual, will be flashing
3.   to toggle selection,   to select
4.   to return to normal display
5. Manual mode is now active

4.3.2. Modifying Manual Output Percentage

1. From normal display,   until showing:

MODIFY	<->
CONTROLLER OUTPUTS	

2.   to enter Manual Mode modify menu

3.   until proper controller is selected (CP, HW or SF)
4.   to enter modify mode
5.    to make change to Manual Mode output percentage
6.   to program change
7.   to return to normal display
8. Controller will move to selected output percentage











4.4. How Do I Modify a Controller Setpoint

The Cold Product, Hot Water and Safety Flow Controllers each have an associated operating setpoint. This setpoint represents the value desired for operation of this portion of the process. The same method applies whether the controller is set for PID mode of operation (modulating 4-20 mA output) or On/Off mode of operation (Relay).

 NOTE: A menu option exists for selecting whether or not setpoint changes may be made from the RUN mode. If set to NO, setpoint changes may only be made under the appropriate Controller Setup Menu while in the Program mode. If set to YES, setpoints may be modified as shown in the upcoming section. To toggle this function, refer to the appropriate (CP, HW, or SF) Controller Setup Menu in section 5.

1. From normal display,   until showing:

MODIFY	<->
SETPOINT VALUES	











2.   to enter modify menu
3.   until proper controller is selected (CP, HW or SF)
4.   to enter modify mode
5.    to make change to setpoint value
6.   to program change

7.  to return to normal display
8. Controller will move to selected setpoint

4.5. How Do I Modify Controller PID Tuning Parameters

 NOTE: A menu option exists for selecting whether or not PID Tuning Parameter changes may be made from the RUN mode. If set to NO, changes may only be made under the appropriate Controller Setup Menu while in the Program mode. If set to YES, changes may be made as shown in the upcoming section. To toggle this function, refer to the appropriate (CP, HW, or SF) Controller Setup Menu in section 5.

1.  until display shows:

SELECT <->
 CONTROLLER SETUP
2. , then  until controller which you wish to modify is flashing
3.  to select
4. Use  and  to navigate through associated menu options
5.  to modify the desired parameter
6.  or  to change current value
7.  to save change
8.  to return to normal display

5. Program Reference - Function Setup Menu

Within this section, parameters that affect operation, display, printing, and other user accessible features are illustrated. Functions are defined as follows:

STLR = Safety Thermal Limit Recorder	(Standard function)
SFLR = Safety Flow Limit Recorder	(Optional Function)
CPRC = Cold Product Recorder	(Optional function)
HWC = Hot Water Controller	(Optional function)

Prior to entering the programming menus, be sure you have reviewed the *General Instrument Operation* section of this manual. Information about Display and Keypad operation is covered, as well as instructions for toggling between *RUN MODE* and *PROGRAM MODE*. Menu options will differ depending on the current operating mode.

 **CAUTION:** Unless otherwise specified, the model AV-9900 HTST will be provided pre-programmed from the Factory. Prior to making modifications, it is recommended that you record current settings.

5.1. Function Setup Menu - STLR

The following section, STLR (Safety Thermal Limit Recorder), will illustrate the various programming options related to this function.



5.1.1. STLR - Shunt Position - RUN MODE

While in the RUN MODE, changes may be made as to which parameters display on the user screen. All parameters may not be accessible, as many are dependent on activation by another parameter. Access is gained as follows:

 Note: Refer to General Instrument Operations section for instructions on identifying RUN and PROGRAM mode of operation.

From the Normal Display,   key until the following is visible:

```
SELECT <>
FUNCTION SETUP
```







With **FUNCTION** shown in the lower display line,   key. The following will now be visible on the user display:

```
SELECT FUNCTION
STLR   XXXX   XXXX
```

 NOTE: XXXX will vary depending on which options the unit has

  key until STLR is flashing, then   key to select. Available parameters are:

STLR INP DISPLAY OPT
[NOT DISPLAYED]
[IN CONTINUOUS MODE]
[IN SEQUENTIAL MODE]
[IN BOTH MODES]





  to change,   to choose,   to save

Definition: This parameter, when active, will display the temperature inputs from the Hot Product Probe to the user display.

  TO ADVANCE TO NEXT SELECTION

STLR INPUT DISPLAY BOTH
[YES]
[NO]

 NOTE: This parameter not shown if STLR INP DISPLAY OPT set to NOT DISPLAYED.



  to change,  or  to choose,   to save

Definition: If STLR Input is being displayed, this parameter selects whether both input 1 (Primary) and input 2 (Secondary) are displayed, or if only input 1 (Primary) is displayed.

  TO ADVANCE TO NEXT SELECTION

STLR INP CORRECTION
.X⁰F



 NOTE: °C shown if unit set for Celsius

  to change,   to choose,   to save

Definition: This parameter allows a correction factor to be added to the STLR Input Values. It is used to correct discrepancies between the actual temperature value, and the value that prints to the chart.

  TO ADVANCE TO NEXT SELECTION





STLR OUT DISPLAY OPT
[NOT DISPLAYED]
[IN CONTINUOUS MODE]
[IN SEQUENTIAL MODE]
[IN BOTH MODES]

 MOD to change,   to choose,  ENTER to save



Definition: This parameter displays as ON or OFF on the user display. It is based on meeting the requirement of Diversion Setpoint + Deadband. May or may not indicate forward flow condition - dependent on presence of SFLR function.

 TO ADVANCE TO NEXT SELECTION

STLR SP DISPLAY OPT
[NOT DISPLAYED]
[IN CONTINUOUS MODE]
[IN SEQUENTIAL MODE]
[IN BOTH MODES]

 MOD to change,   to choose,  ENTER to save

Definition: This parameter, when active, will display the **CURRENTLY ACTIVE** Diversion Setpoint.

This completes STLR program options -  RESET to return to main display, or  to return to start of **FUNCTION MENU**.

5.1.2. STLR - Shunt Position - PROGRAM MODE

While in the PROGRAM MODE, changes may be made as to which parameters display on the user screen, in addition to which parameters print to the chart. All parameters may not be accessible, as many are dependent on activation by another parameter. Access is gained as follows:

 Note: Refer to General Instrument Operations section for instructions on identifying RUN and PROGRAM mode of operation.

From the Normal Display,  key until the following is visible:

```
SELECT <->
FUNCTION SETUP
```

With FUNCTION shown in the lower display line,  key. The following will now be visible on the user display:

```
SELECT FUNCTION
STLR XXXX XXXX
```

 NOTE: XXXX will be vary depending on which options the unit has

 key until STLR is flashing,  key to select. Available parameters are:

```
STLR INPUT USAGE
[NORMAL]
[SIMULATED]
```





 to change,  or  to choose,  to save

Definition: This parameter selects NORMAL run mode, with a SIMULATED run mode option for demonstration purposes. The SIMULATED VARIABLES menu will allow changes such as period and amplitude of the simulated variable to be made.

 TO ADVANCE TO NEXT SELECTION

STLR INP TRANSMIT TO
CURRENT OUTPUT X





NOTE: X = Current output 0-4. Be sure current output selected is not used by another function.

 MOD to change,   to choose,  ENTER to save

Definition: This parameter allows the STLR Hot Product Input signal to be sent out as a 4-20 mA retransmission signal.

  TO ADVANCE TO NEXT SELECTION





STLR INPUT RECORDING
[RED]
[BLACK]
[BLUE]
[GREEN]
[NOT RECORDED]

 MOD to change,  or  to choose,  ENTER to save

Definition: This parameter determines if the temperature from the Hot Product Probe input is printed to the chart, and if so, in which color. The factory default is RED.

  TO ADVANCE TO NEXT SELECTION

STLR INP DISPLAY OPT
[IN BOTH MODES]
[IN CONTINUOUS]
[IN SEQUENTIAL]
[NOT DISPLAYED]

 MOD to change,   to choose,  ENTER to save

Definition: This parameter, when active, will display the temperature inputs (Primary - Secondary) from the Hot Product Probe.

  TO ADVANCE TO NEXT SELECTION

STLR INPUT DISPLAY BOTH
[YES]
[NO]

NOTE: This parameter is not shown if STLR INP DISPLAY OPT is set to NOT DISPLAYED.





 MOD to change,  or  to choose,  ENTER to save

Definition: If STLR Input is being displayed, this parameter selects whether both input 1 (Primary) and input 2 (Secondary) are displayed, or if only input 1 (Primary) is displayed.

  TO ADVANCE TO NEXT SELECTION

STLR INP CORRECTION
.X°F

NOTE: °C shown if unit set for Celsius

 MOD to change,   to choose,  ENTER to save

Definition: This parameter allows a correction factor to be added to the STLR Input Values. It is used to correct discrepancies between the actual temperature value, and the value that prints to the chart.

  TO ADVANCE TO NEXT SELECTION



STLR OUT DISPLAY OPT
[NOT DISPLAYED]
[IN CONTINUOUS MODE]
[IN SEQUENTIAL MODE]
[IN BOTH MODES]

 MOD to change,   to choose,  ENTER to save

Definition: This parameter displays as ON or OFF on the user display. It is based on meeting the requirement of Diversion Setpoint + Deadband.

 TO ADVANCE TO NEXT SELECTION





STLR SP RECORDING
[NOT RECORDED]
[RED]
[GREEN]
[BLUE]

 to change,   to choose,  to save



Definition: This parameter will determine if the STLR Diversion Setpoint is recorded to the chart, and if so, in which color. The factory default is GREEN.

 TO ADVANCE TO NEXT SELECTION

STLR SP DISPLAY OPT
[NOT DISPLAYED]
[IN CONTINUOUS MODE]
[IN SEQUENTIAL MODE]
[IN BOTH MODES]

 to change,   to choose,  to save

Definition: This parameter, when active, will display the *CURRENTLY ACTIVE* Diversion Setpoint.

This completes STLR program options -  to return to main display, or  to return to start of **FUNCTION MENU**.

5.2. Function Setup Menu - CPRC

The following section, CPRC (Cold Product Recorder Controller), will illustrate the various programming options related to this function.

 Note: This is an optional function, and may not be present on your unit.

5.2.1. CPRC - Shunt Position - RUN MODE

While in the RUN MODE, changes may be made to many parameters considered non-operation critical. All parameters may not be accessible, as many are dependent on activation by another parameter. Access is gained as follows:

 Note: Refer to General Instrument Operations section for instructions on identifying RUN and PROGRAM mode of operation.

From the Normal Display,  key until the following is visible:

```
SELECT      <->
FUNCTION SETUP
```





With FUNCTION shown in the lower display line,  key. The following will now be visible on the user display:

```
SELECT FUNCTION
STLR      XXXX   XXXX
```

 NOTE: XXXX will be vary depending on which options the unit has

 key until CPRC is flashing,  key to select. Available parameters are:

```
CPRC INP DISPLAY OPT
[ NOT DISPLAYED ]
[ IN CONTINUOUS MODE ]
[ IN SEQUENTIAL MODE ]
[ IN BOTH MODES ]
```

 to change,   to choose,  to save

Definition: This parameter, when active, will display the value corresponding to the CPRC temperature input. Units will be as programmed under Instrument settings.

 TO ADVANCE TO NEXT SELECTION

CPRC INP CORRECTION
.X UNITS

♪ Note: Units will be as selected in Program Mode

  to change,   to choose,   to save

Definition: This parameter allows a correction factor to be added to the CPRC input value. It is used to correct discrepancies between the actual cold product value, and the value that prints to the chart.

  TO ADVANCE TO NEXT SELECTION







CPRC OUT DISPLAY OPT
[NOT DISPLAYED]
[IN CONTINUOUS MODE]
[IN SEQUENTIAL MODE]
[IN BOTH MODES]

  to change,   to choose,   to save



Definition: This parameter, when active, will display the output of the CPRC PID Controller. A Controller **MUST** be active. The units will be in % of output.

  TO ADVANCE TO NEXT SELECTION

CPRC SP DISPLAY OPT
[NOT DISPLAYED]
[IN CONTINUOUS MODE]
[IN SEQUENTIAL MODE]
[IN BOTH MODES]

  to change,   to choose,   to save

Definition: This parameter, when active, will display the current setpoint for the PID Controller associated with the Cold Product Recorder.

This completes CPRC program options -   to return to main display, or  to return to start of **FUNCTION MENU**.



5.2.2. CPRC - Shunt Position - PROGRAM MODE

While in the PROGRAM MODE, changes may be made to parameters which affect the operation of the CPRC. All parameters may not be accessible, as many are dependent on activation by another parameter. Access is gained as follows:

 Note: Refer to General Instrument Operations section for instructions on identifying RUN and PROGRAM mode of operation.

From the Normal Display,  key until the following is visible:

```
SELECT <->
FUNCTION SETUP
```





With FUNCTION shown in the lower display line,   key. The following will now be visible on the user display:

```
SELECT FUNCTION
STLR XXXX XXXX
```

 NOTE: XXXX will be vary depending on which options the unit has

 key until CPRC is flashing,  key to select. Available parameters are:

```
CPRC INPUT NUMBER
[0 THROUGH 8]
```

 to change,   to choose,  to save

Definition: This parameter tells the unit which of the possible eight inputs is tied directly to the Cold Product Sensor (mA or RTD).

 TO ADVANCE TO NEXT SELECTION

CPRC INPUT USAGE
[NORMAL]
[SIMULATED]



 MOD to change,  or  to choose,  ENTER to save

Definition: This parameter selects NORMAL run mode, with a SIMULATED run mode option for demonstration purposes.

  TO ADVANCE TO NEXT SELECTION

CPRC INP TRANSMIT TO
CURRENT OUTPUT X

 NOTE: X = Current output 0-4. Be sure current output selected is not used by another function.

 MOD to change,   to choose,  ENTER to save

Definition: This parameter allows the CPRC Input signal to be sent out as a 4-20 mA retransmission signal.

  TO ADVANCE TO NEXT SELECTION





CPRC INPUT RECORDING
[RED]
[BLACK]
[BLUE]
[GREEN]
[NOT RECORDED]

 MOD to change,  or  to choose,  ENTER to save

Definition: This parameter, if active, allows the input from the Cold Product Sensor to be printed to the chart.

  TO ADVANCE TO NEXT SELECTION

CPRC INP DISPLAY OPT
[IN BOTH MODES]
[IN CONTINUOUS]
[IN SEQUENTIAL]
[NOT DISPLAYED]





 MOD to change,   to choose,  ENTER to save

Definition: This parameter, when active, will display the RAW Cold Product Temperature input value.

  TO ADVANCE TO NEXT SELECTION

CPRC INP CORRECTION
.X UNITS



 Note: Units will be as selected in Program Mode

 MOD to change,   to choose,  ENTER to save

Definition: This parameter allows a correction factor to be added to the Cold Product input value. It is used to correct discrepancies between the actual cold product value, and the value that prints to the chart.

  TO ADVANCE TO NEXT SELECTION

CPRC CONTROLLER TYPE
[PID]
[ON/OFF]

 MOD to change,  or  to choose,  ENTER to save

Definition: This parameter allows the user to choose the type of control action applied to the CPRC control output.

  TO ADVANCE TO NEXT SELECTION

CPRC CURRENT OUTPUT
[1 THROUGH 4]





NOTE: This parameter only active if PID chosen as control type

  to change,   to choose,   to save

Definition: This parameter will tie a PID control output to one of the available 4-20 mA outputs. A mA output board MUST be present - be sure no other functions utilize the same re-transmit.

  TO ADVANCE TO NEXT SELECTION







CPRC OUT RECORDING
[RED]
[BLACK]
[BLUE]
[GREEN]
[NOT RECORDED]

  to change,  or  to choose,   to save

Definition: This parameter, when active, will record the resulting output of the CPRC PID Controller. Only applies if PID control selected.

  TO ADVANCE TO NEXT SELECTION

CPRC OUT DISPLAY OPT
[NOT DISPLAYED]
[IN CONTINUOUS MODE]
[IN SEQUENTIAL MODE]
[IN BOTH MODES]

  to change,   to choose,   to save

Definition: This parameter, when active, will display the resulting output of the CPRC PID Controller, if controller is active.

  TO ADVANCE TO NEXT SELECTION





CPRC SP RECORDING
[RED]
[BLACK]
[BLUE]
[GREEN]
[NOT RECORDED]

 to change,  or  to choose,  to save

Definition: This parameter, if active, allows the setpoint to be printed to the chart.

 TO ADVANCE TO NEXT SELECTION

CPRC SP DISPLAY OPT
[NOT DISPLAYED]
[IN CONTINUOUS MODE]
[IN SEQUENTIAL MODE]
[IN BOTH MODES]

 to change,   to choose,  to save

Definition: This parameter, if active, allows the current Setpoint of the PID controller associated with the Cold Product to be displayed.

 TO ADVANCE TO NEXT SELECTION

CPRC ALARM1 TYPE
[NONE/OFF]
[LOW SIGNAL/VALUE]
[HIGH RATE/VALUE]







 to change,   to choose,  to save

Definition: This parameter allows the user to select an optional alarm for the Cold Product process. This alarm may be tied to an event flag, LED, or relay.

 TO ADVANCE TO NEXT SELECTION

CPRC ALARM1 SETPOINT
X °F







NOTE: Will display in °C if unit set for Celcius

  to change,   to choose,   to save

Definition: This parameter allows the user to set the CPRC ALARM 1 Setpoint Value.

  TO ADVANCE TO NEXT SELECTION

CPRC ALARM2 TYPE
[NONE/OFF]
[LOW SIGNAL/VALUE]
[HIGH RATE/VALUE]







  to change,   to choose,   to save

Definition: This parameter allows the user to select an optional alarm for the Cold Product process. This alarm may be tied to an event flag, LED, or relay.



  TO ADVANCE TO NEXT SELECTION

CPRC ALARM2 SETPOINT
X °F

NOTE: Will display in °C if unit set for Celcius

  to change,   to choose,   to save

Definition: This parameter allows the user to set the CPRC ALARM 2 Setpoint Value.

This completes CPRC program options -   to return to main display, or  to return to start of **FUNCTION MENU**.

5.3. Function Setup Menu - HWC

The following section, HWC (Hot Water Controller), will illustrate the various programming options related to this function.

 Note: This is an optional function, and may not be present on your unit.

5.3.1. HWC - Shunt Position - RUN MODE

While in the RUN MODE, changes may be made to many parameters considered non-operation critical. All parameters may not be accessible, as many are dependent on activation by another parameter. Access is gained as follows:

 Note: Refer to General Instrument Operations section for instructions on identifying RUN and PROGRAM mode of operation.



From the Normal Display,  key until the following is visible:

```
SELECT          <->
FUNCTION SETUP
```





With FUNCTION shown in the lower display line,  key. The following will now be visible on the user display:

```
SELECT FUNCTION
STLR   XXXX   XXXX
```

 NOTE: XXXX will be vary depending on which options the unit has

 key until HWC is flashing (parameter may not initially be shown on display),  key to select. Available parameters are:







HWC INP DISPLAY OPT
[NOT DISPLAYED]
[IN CONTINUOUS MODE]
[IN SEQUENTIAL MODE]
[IN BOTH MODES]

  to change,   to choose,   to save

Definition: This parameter, when active, will display the result of the Hot Water Temperature input.

  TO ADVANCE TO NEXT SELECTION







HWC OUT DISPLAY OPT
[NOT DISPLAYED]
[IN CONTINUOUS MODE]
[IN SEQUENTIAL MODE]
[IN BOTH MODES]

  to change,   to choose,   to save



Definition: This parameter, when active, displays the output of the controller associated with the Hot Water function.

  TO ADVANCE TO NEXT SELECTION

HWC SP DISPLAY OPT
[NOT DISPLAYED]
[IN CONTINUOUS MODE]
[IN SEQUENTIAL MODE]
[IN BOTH MODES]

  to change,   to choose,   to save

Definition: This parameter, when active, will display the current setpoint for the PID Controller associated with the Hot Water Controller.

This completes HWC program options -   to return to main display, or  to return to start of **FUNCTION MENU**.

5.3.2. HWC - Shunt Position - PROGRAM MODE

While in the PROGRAM MODE, changes may be made to parameters which affect the operation of the HWC. All parameters may not be accessible, as many are dependent on activation by another parameter. Access is gained as follows:

 Note: Refer to General Instrument Operations section for instructions on identifying RUN and PROGRAM mode of operation.

From the Normal Display,  key until the following is visible:

```
SELECT <->
FUNCTION SETUP
```



With FUNCTION shown in the lower display line,  key. The following will now be visible on the user display:

```
SELECT FUNCTION
STLR   XXXX   XXXX
```

 NOTE: XXXX will vary depending on which options the unit has

 key until HWC is flashing, then  key to select. Available parameters are:

```
HWC INPUT NUMBER
[0 THROUGH 8]
```

 to change,   to choose,  to save

Definition: This parameter tells the unit which of the possible eight inputs is tied directly to the Hot Water Sensor (mA or RTD).

 TO ADVANCE TO NEXT SELECTION

HWC INPUT USAGE
[NORMAL]
[SIMULATED]





 MOD to change,  or  to choose,  ENTER to save

Definition: This parameter selects NORMAL run mode, with a SIMULATED run mode option for demonstration purposes.

  TO ADVANCE TO NEXT SELECTION

HWC INP TRANSMIT TO
CURRENT OUTPUT X



 NOTE: X = Current output 0-4. Be sure current output selected is not used by another function.

 MOD to change,   to choose,  ENTER to save

Definition: This parameter allows the HWC Input signal to be sent out as a 4-20 mA retransmission signal.

  TO ADVANCE TO NEXT SELECTION





HWC INPUT RECORDING
[RED]
[BLACK]
[BLUE]
[GREEN]
[NOT RECORDED]

 MOD to change,  or  to choose,  ENTER to save

Definition: This parameter, if active, allows the input from the Hot Water Sensor to be printed to the chart.

  TO ADVANCE TO NEXT SELECTION

HWC INP DISPLAY OPT
[IN BOTH MODES]
[IN CONTINUOUS]
[IN SEQUENTIAL]
[NOT DISPLAYED]

 MOD to change,   to choose,  ENTER to save

Definition: This parameter, when active, will display the Hot Water Temperature input value.

  TO ADVANCE TO NEXT SELECTION

HWC CONTROLLER TYPE
[PID]
[ON/OFF]

 MOD to change,  or  to choose,  ENTER to save

Definition: This parameter allows the user to choose the type of control action applied to the HWC control output.

  TO ADVANCE TO NEXT SELECTION

HWC CURRENT OUTPUT
[1 THROUGH 4]



 NOTE: This parameter only active if PID chosen as control type

 MOD to change,   to choose,  ENTER to save

Definition: This parameter will tie a PID control output to one of the available 4-20 mA outputs. A mA output board MUST be present - be sure no other functions utilize the same re-transmit.

  TO ADVANCE TO NEXT SELECTION

HWC OUT RECORDING
[RED]
[BLACK]
[BLUE]
[GREEN]
[NOT RECORDED]

 MOD to change,  or  to choose,  ENTER to save

Definition: This parameter, when active, will record the resulting output of the HWC PID Controller, if controller is active.

  TO ADVANCE TO NEXT SELECTION

HWC OUT DISPLAY OPT
[NOT DISPLAYED]
[IN CONTINUOUS MODE]
[IN SEQUENTIAL MODE]
[IN BOTH MODES]

 MOD to change,   to choose,  ENTER to save

Definition: This parameter, when active, will display the resulting output of the HWC PID Controller, if controller is active.

  TO ADVANCE TO NEXT SELECTION





HWC SP RECORDING
[RED]
[BLACK]
[BLUE]
[GREEN]
[NOT RECORDED]

 MOD to change,  or  to choose,  ENTER to save

Definition: This parameter, if active, allows the setpoint of the HWC PID controller to be printed to the chart.

  TO ADVANCE TO NEXT SELECTION





HWC SP DISPLAY OPT
[NOT DISPLAYED]
[IN CONTINUOUS MODE]
[IN SEQUENTIAL MODE]
[IN BOTH MODES]

 MOD to change,   to choose,  ENTER to save

Definition: This parameter, if active, allows the current Setpoint of the PID controller associated with the Hot Water to be displayed.

  TO ADVANCE TO NEXT SELECTION

HWC ALARM1 TYPE
[NONE/OFF]
[LOW SIGNAL/VALUE]
[HIGH RATE/VALUE]

 MOD to change,   to choose,  ENTER to save

Definition: This parameter allows the user to select an optional alarm for the Hot Water Loop. This alarm may be tied to an event flag, LED, or relay.

  TO ADVANCE TO NEXT SELECTION

HWC ALARM1 SETPOINT
X °F







 NOTE: Will display in °C if unit set for Celcius

 MOD to change,   to choose,  ENTER to save

Definition: This parameter allows the user to set the HWC ALARM 1 Setpoint Value.

  TO ADVANCE TO NEXT SELECTION

HWC ALARM2 TYPE
[NONE/OFF]
[LOW SIGNAL/VALUE]
[HIGH RATE/VALUE]







  to change,   to choose,   to save

Definition: This parameter allows the user to select an optional alarm for the Hot Water Loop. This alarm may be tied to an event flag, LED, or relay.



  TO ADVANCE TO NEXT SELECTION

HWC ALARM2 SETPOINT
X °F

 NOTE: Will display in °C if unit set for Celcius

  to change,   to choose,   to save

Definition: This parameter allows the user to set the HWC ALARM 2 Setpoint Value.

This completes HWC program options -   to return to main display, or  to return to start of **FUNCTION MENU**.

5.4. Function Setup Menu - SFLR

The following section, SFLR (Safety Flow Limit Recorder), will illustrate the various programming options related to this function.

 Note: This is an optional function, and may not be present on your unit.



5.4.1. SFLR - Shunt Position - RUN MODE

While in the RUN MODE, changes may be made to many parameters considered non-operation critical. All parameters may not be accessible, as many are dependent on activation by another parameter. Access is gained as follows:

 Note: Refer to General Instrument Operations section for instructions on identifying RUN and PROGRAM mode of operation.





From the Normal Display,   key until the following is visible:

```
SELECT          <->
FUNCTION SETUP
```





With FUNCTION shown in the lower display line,   key. The following will now be visible on the user display:

```
SELECT FUNCTION
STLR   XXXX   XXXX
```

 NOTE: XXXX will be vary depending on which options the unit has

  key until SFLR is flashing (parameter may not initially be shown on display),   key to select. Available parameters are:







SFLR INP DISPLAY OPT
[NOT DISPLAYED]
[IN CONTINUOUS MODE]
[IN SEQUENTIAL MODE]
[IN BOTH MODES]

  to change,   to choose,   to save

Definition: This parameter, when active, will display the result of the SFLR input.

  TO ADVANCE TO NEXT SELECTION







SFLR OUT DISPLAY OPT
[NOT DISPLAYED]
[IN CONTINUOUS MODE]
[IN SEQUENTIAL MODE]
[IN BOTH MODES]

  to change,   to choose,   to save



Definition: This parameter, when active, displays the output of the controller associated with the SFLR function.

  TO ADVANCE TO NEXT SELECTION

SFLR SP DISPLAY OPT
[NOT DISPLAYED]
[IN CONTINUOUS MODE]
[IN SEQUENTIAL MODE]
[IN BOTH MODES]

  to change,   to choose,   to save

Definition: This parameter, when active, will display the current setpoint for the PID Controller associated with the SFLR Controller.

This completes SFLR program options -   to return to main display, or  to return to start of **FUNCTION MENU**.

5.4.2. SFLR - Shunt Position - PROGRAM MODE

While in the PROGRAM MODE, changes may be made to parameters which affect the operation of the SFLR. All parameters may not be accessible, as many are dependent on activation by another parameter. Access is gained as follows:

 Note: Refer to General Instrument Operations section for instructions on identifying RUN and PROGRAM mode of operation.

From the Normal Display,  key until the following is visible:

```
SELECT <->
FUNCTION SETUP
```

With FUNCTION shown in the lower display line,  key. The following will now be visible on the user display:

```
SELECT FUNCTION
STLR XXXX XXXX
```

 NOTE: XXXX will be vary depending on which options the unit has

 key until SFLR is flashing, then  key to select. Available parameters are:







```
SFLR DISPLAY UNITS
[GPH]
[GPM]
[%]
[LPM]
[LPH]
```

 to change,  or  to choose,  to save

Definition: This parameter specifies the active units for flow display.

 TO ADVANCE TO NEXT SELECTION

SFLR INPUT NUMBER
[0 THROUGH 8]

  to change,   to choose,   to save

Definition: This parameter tells the unit which of the possible eight inputs is tied directly to the Flow Meter.

  TO ADVANCE TO NEXT SELECTION

SFLR INPUT USAGE
[NORMAL]
[SIMULATED]

  to change,  or  to choose,   to save

Definition: This parameter selects NORMAL run mode, with a SIMULATED run mode option for demonstration purposes.

  TO ADVANCE TO NEXT SELECTION

SFLR INP TRANSMIT TO
CURRENT OUTPUT X

 NOTE: X = Current output 0-4. Be sure current output selected is not used by another function.

  to change,   to choose,   to save

Definition: This parameter allows the SFLR Input signal to be sent out as a 4-20 mA retransmission signal.

  TO ADVANCE TO NEXT SELECTION

SFLR INPUT RECORDING
[RED]
[BLACK]
[BLUE]
[GREEN]
[NOT RECORDED]







  to change,  or  to choose,   to save

Definition: This parameter, if active, allows the input from the Flow Rate to be printed to the chart.

Default: Black

  TO ADVANCE TO NEXT SELECTION

SFLR INP DISPLAY OPT
[IN BOTH MODES]
[IN CONTINUOUS]
[IN SEQUENTIAL]
[NOT DISPLAYED]







  to change,   to choose,   to save

Definition: This parameter, when active, will display the Flow Rate input value.

  TO ADVANCE TO NEXT SELECTION

SFLR INP CORRECTION
.X units

 NOTE: Units, as programmed, will be displayed

  to change,   to choose,   to save

Definition: This parameter allows a correction factor to be added to the SFLR Input Values. It is used to correct discrepancies between the actual Flow Rate value, and the value that displays / prints to the chart.

  TO ADVANCE TO NEXT SELECTION

SFLR CONTROLLER TYPE
[PID]
[ON/OFF]







  to change,  or  to choose,   to save

Definition: This parameter allows the user to choose the type of control action applied to the SFLR control output.

  TO ADVANCE TO NEXT SELECTION

SFLR CURRENT OUTPUT
[1 THROUGH 4]





 NOTE: This parameter only active if PID chosen as control type

  to change,   to choose,   to save

Definition: This parameter will tie a PID control output to one of the available 4-20 mA outputs. A mA output board MUST be present - be sure no other functions utilize the same re-transmit.

  TO ADVANCE TO NEXT SELECTION



SFLR OUT RECORDING
[RED]
[BLACK]
[BLUE]
[GREEN]
[NOT RECORDED]

  to change,  or  to choose,   to save

Definition: This parameter, when active, will record the resulting output of the SFLR PID Controller, if controller is active.

  TO ADVANCE TO NEXT SELECTION

SFLR OUT DISPLAY OPT
[NOT DISPLAYED]
[IN CONTINUOUS MODE]
[IN SEQUENTIAL MODE]
[IN BOTH MODES]

  to change,   to choose,   to save

Definition: This parameter, when active, will display the resulting output of the SFLR PID Controller, if controller is active.

  TO ADVANCE TO NEXT SELECTION







SFLR SP RECORDING
[RED]
[BLACK]
[BLUE]
[GREEN]
[NOT RECORDED]

  to change,  or  to choose,   to save

Definition: This parameter, if active, allows the setpoint of the SFLR PID controller to be printed to the chart.

  TO ADVANCE TO NEXT SELECTION

SFLR SP DISPLAY OPT
[NOT DISPLAYED]
[IN CONTINUOUS MODE]
[IN SEQUENTIAL MODE]
[IN BOTH MODES]





  to change,   to choose,   to save

Definition: This parameter, if active, allows the current Setpoint of the PID controller associated with the Hot Water to be displayed.

  TO ADVANCE TO NEXT SELECTION

NOTE: SFL2 functions allow for a second On/Off or PID control output. This function is NOT utilized on typical Pasteurization loops.

SFLR ALARM1 TYPE
[NONE/OFF]
[LOW SIGNAL/VALUE]
[HIGH RATE/VALUE]



  to change,   to choose,   to save

Definition: MUST remain at “High Rate/Value” selection for proper utilization as “Loss of Signal” alarm. Causes Alarm 1 relay to be failsafe active when above “Loss of Signal” setpoint. Below Loss of Signal setpoint condition will cause relay to open, sending fault signal to Legal Flow Controller. Will result in system divert to balance tank.

  TO ADVANCE TO NEXT SELECTION

SFLR ALARM1 SETPOINT
X units







NOTE: Units, as programmed, will be displayed

  to change,   to choose,   to save

Definition: This parameter allows the user to set the SFLR ALARM 1 Setpoint Value. This is the legal “Loss of Signal” setpoint value.

  TO ADVANCE TO NEXT SELECTION

SFLR ALARM2 TYPE
[NONE/OFF]
[LOW SIGNAL/VALUE]
[HIGH RATE/VALUE]

  to change,   to choose,   to save

Definition: MUST remain at “LOW SIGNAL/VALUE” selection for proper utilization as “High Flow” alarm. Causes Alarm 2 relay to be failsafe active when above “High Flow” setpoint. Above High Flow setpoint condition will cause relay to open, sending fault signal to Legal Flow Controller. Will result in system divert to balance tank.



  TO ADVANCE TO NEXT SELECTION

SFLR ALARM2 SETPOINT
X units

NOTE: Units, as programmed, will be displayed

  to change,   to choose,   to save

Definition: This parameter allows the user to set the SFLR ALARM 2 Setpoint Value.

This completes SFLR program options -   to return to main display, or  to return to start of **FUNCTION MENU**.

6. Program Reference - Controller Setup Menu

The following section will illustrate the various programming options related to Control function.

 **CAUTION:** Unless otherwise specified, the model AV-9900 HTST will be provided pre-programmed from the Factory. Default numbers will be present for PID tuning parameters. As all control loops differ in operation, it will be necessary to modify the TUNE parameters for each PID control loop in order to obtain proper operation. If you are making modifications to program parameters on a unit that has been in operation, RECORD ALL PARAMETERS before making changes.



6.1. Controller Setup Menu - STLR

6.1.1. STLR - Shunt Position - PROGRAM MODE

While in the PROGRAM MODE, changes may be made to the STLR Diversion Setpoint parameters. Access is gained as follows:

From the Normal Display,   key until the following is visible:

```
SELECT <->
CONTROLLER SETUP
```

With FUNCTION shown in the lower display line,   key. The following will now be visible on the user display:

```
CONTROL FUNCTION
STLR   XXXX   XXXX
```

 **NOTE:** XXXX will be vary depending on which options the unit has

  key until STLR is flashing, then   key to select. Available parameters are:

STLR OUT DISPLAY TAG
[USER ENTERED TEXT]

 NOTE: Refer to **General Instrument Operation - Modifying Text** for information on this operation.

Definition: This text parameter defines the tag that is shown on the user display for the STLR diversion ON or OFF result.

 TO ADVANCE TO NEXT SELECTION





STLR SP DISPLAY TAG
[USER ENTERED TEXT]

 NOTE: Refer to **General Instrument Operation - Modifying Text** for information on this operation.

Definition: This text parameter defines the tag that is shown on the user display for the STLR Diversion setpoint.

 TO ADVANCE TO NEXT SELECTION





STLR SP DECIMAL POS
[0 THROUGH 3]

 to change,   to choose,  to save

Definition: This parameter determines the active number of decimal places shown for the STLR Diversion setpoint as shown on the user display.

 TO ADVANCE TO NEXT SELECTION

STLR NUM SETPOINTS
[1 THROUGH 5]

  to change,   to choose,   to save

Definition: This parameter determines the number of active STLR Diversion Setpoints.

 NOTE: Choosing an EQUAL number of STLR Diversion Setpoints and HWC's (Hot Water Controllers) will tie a unique HWC program set to each Diversion Setpoint. This allows PID Hot Water Controller tuning to vary in settings for each of the individual STLR Diversion Setpoints.

  TO ADVANCE TO NEXT SELECTION

STLR SPX VALUE
[Y UNITS]

X = Diversion Setpoint 1 through 5
Y = Setpoint Value
Units = °F or °C as chosen in setup







  to change,   to choose,   to save

Definition: This parameter is one of the 5 available Diversion Setpoints, entered in either units of °F or °C.

  TO ADVANCE TO NEXT SELECTION

STLR SPX DEADBAND
[Y UNITS]

X = Diversion Setpoint 1 through 5
Y = Deadband Value
Units = °F or °C as chosen in setup

  to change,   to choose,   to save

Definition: The Deadband parameter is added to its corresponding Diversion Setpoint. Forward Flow is not achieved until the value of Setpoint + Deadband has been met. A unique

Deadband exists for each Diversion Setpoint. Values are entered in either units of °F or °C, as determined by setup. Values are whole numbers unless decimal places active.

 TO ADVANCE TO NEXT SELECTION

 **Note: Previous two parameters will be repeated for each of the active Diversion Setpoints.**



STLR CURRENT SP
[1 THROUGH 5]

 to change,   to choose,  to save

Definition: This value allows the selection of currently active STLR Diversion Setpoint while in the *STLR Controller Program Menu*.

 **NOTE:** The new Diversion Setpoint does NOT take effect until the unit **Program Jumper** is moved from PROGRAM to RUN position.

 **NOTE:** This parameter will not be visible if only ONE Diversion Setpoint is active.



This completes STLR Controller program options -  to return to main display,  to return to start of **CONTROLLER SETUP MENU**.

6.1.2. STLR - Shunt Position - RUN MODE

While in the RUN MODE, only selection of an already programmed Diversion Setpoint may be performed. Access is gained as follows:

From the Normal Display,   key until the following is visible:

SELECT <>
CONTROLLER SETUP

With FUNCTION shown in the lower display line,   key. The following will now be visible on the user display:

CONTROL FUNCTION
STLR XXXX XXXX

 NOTE: XXXX will be vary depending on which options the unit has.

 NOTE: No choices given if no Cold Product or Hot Water controllers active.

  key until STLR is flashing, then   key to select. Available parameters are:



STLR CURRENT SP
[1 THROUGH 5]

  to change,   to choose,   to save

Definition: This value allows the selection of currently active STLR Diversion Setpoint while in the *STLR Controller Program Menu*.

 NOTE: The new Diversion Setpoint does NOT take effect until the unit **Program Jumper** is moved from PROGRAM to RUN position.

 NOTE: This parameter will not be visible if only ONE Diversion Setpoint is active.

This completes STLR Controller program options -   to return to main display,  to return to start of **CONTROLLER SETUP MENU**.

6.2. Controller Setup Menu - CPRC

The following section, CPRC (Cold Product Recorder Controller), will illustrate the various programming options related to this function.

 NOTE: Options exist for both ON/OFF and PID methods of control. Before proceeding with changes, be sure to determine the current method of operation. Settings may be viewed in the **CPRC Function Setup Menu**.

6.2.1. CPRC Controller - ON/OFF- Shunt Position - PROGRAM MODE

While in the PROGRAM MODE, changes may be made to the CPRC Control related parameters. Access is gained as follows:

From the Normal Display, press the  key until the following is visible:

SELECT <->
CONTROLLER SETUP

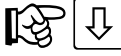
With FUNCTION shown in the lower display line,  key. The following will now be visible on the user display:

CONTROL FUNCTION
STLR XXXX XXXX

 NOTE: XXXX will vary depending on which options the unit has

 key until CPRC is flashing,  key to select. Available parameters are:

CPRC CONTROL TYPE
[DIRECT]
[REVERSE]

 to change,  or  to choose,  to save

Definition: This parameter selects the control action for the ON/OFF Controller associated with the Cold Product.

Direct = Cooling
Reverse = Heating

 TO ADVANCE TO NEXT SELECTION

CPRC OUT DISPLAY TAG
[USER ENTERED TEXT]



NOTE: Refer to **General Instrument Operation - Modifying Text** for information on this operation.

Definition: This text parameter defines the tag that is shown on the user display for the CPRC ON/OFF Control Output.



TO ADVANCE TO NEXT SELECTION

CPRC CONTROL TUNING
[YES]
[NO]



to change,



or



to choose,



to save

Definition: This parameter determines if CPRC Controller ON/OFF tuning parameters are accessible while the unit is in RUN mode.



TO ADVANCE TO NEXT SELECTION

CPRC SETPOINT CHANGE
[YES]
[NO]



to change,



or



to choose,



to save

Definition: This parameter determines if CPRC Controller ON/OFF Setpoint is accessible while the unit is in RUN mode.



TO ADVANCE TO NEXT SELECTION





CPRC SP DISPLAY TAG
[USER ENTERED TEXT]

 NOTE: Refer to **General Instrument Operation - Modifying Text** for information on this operation.

Definition: This text parameter defines the tag that is shown on the user display for the CPRC ON/OFF Setpoint..

 TO ADVANCE TO NEXT SELECTION





CPRC SP DECIMAL POSITION
[0 THROUGH 3]

 to change,   to choose,  to save

Definition: This parameter determines the active number of decimal places shown for the CPRC ON/OFF Setpoint as shown on the user display.

 TO ADVANCE TO NEXT SELECTION

CPRC NUMBER SETPOINTS
[0 THROUGH 1]

 to change,   to choose,  to save

Definition: This parameter determines whether the ON/OFF control is active or not. A “0” de-selects the controller, while a “1” will bring up the remainder of options.





 NOTE: Toggling this value will immediately move to the STLR menu system. Given we are making a change that may adversely affect the system, the user is reminded to verify the STLR setpoints before proceeding.

 NOTE: If option set to “0”, no menu choices present beyond this point.

 TO ADVANCE TO NEXT SELECTION

CPRC SP VALUE
[Y UNITS]

Y = Setpoint Value
Units = °F or °C as chosen in setup





 to change,   to choose,  to save

Definition: This parameter defines the CPRC ON/OFF Setpoint value.

 TO ADVANCE TO NEXT SELECTION



CPRC HYSTERESIS
[Y UNITS]

Y = Proportional Band Value
Units = °F or °C as chosen in setup

 to change,   to choose,  to save

Definition: This parameter defines the CPRC ON/OFF Hysteresis (deadband) value.

 TO ADVANCE TO NEXT SELECTION



This completes CPRC ON/OFF control program options -  to return to main display,
or  to return to start of **CONTROLLER SETUP MENU**.

6.2.2. CPRC Controller - PID - Shunt Position - PROGRAM MODE

While in the PROGRAM MODE, changes may be made to the CPRC Control related parameters. Access is gained as follows:

From the Normal Display, press the   key until the following is visible:

```
SELECT    <->
CONTROLLER SETUP
```

With FUNCTION shown in the lower display line,   key. The following will now be visible on the user display:

```
CONTROL FUNCTION
STLR    XXXX    XXXX
```

 NOTE: XXXX will be vary depending on which options the unit has

  key until CPRC is flashing,   key to select. Available parameters are:

```
CPRC CONTROL TYPE
[DIRECT]
[REVERSE]
```





  to change,  or  to choose,   to save

Definition: This parameter selects the control action for the PID Controller associated with the Cold Product.

Direct = Cooling
Reverse = Heating

  TO ADVANCE TO NEXT SELECTION





CPRC OUT UPPER LIMIT
[1 THROUGH 100 %]

 **MOD** to change,   to choose,  **ENTER** to save

Definition: This parameter establishes a maximum limit for the CPRC PID Controller mA output.

  TO ADVANCE TO NEXT SELECTION





CPRC OUT % ON ERROR
[0 THROUGH 100 %]

 **MOD** to change,   to choose,  **ENTER** to save

Definition: In the event of an error condition, the Controller Output may be forced to a percentage of signal. This will ensure a safe condition during the error period. (Ex: Air-To-Open valve, 0% will ensure valve stays closed)

  TO ADVANCE TO NEXT SELECTION

CPRC OUT SLEW RATE
[%/MIN]

 **MOD** to change,   to choose,  **ENTER** to save

Definition: This parameter establishes the Slew Rate for the Cold Product PID Controller. It's function is to force the controller output to slowly ramp to avoid a rapid start-up. (Ex. 60%/MIN = 1% per Second)

  TO ADVANCE TO NEXT SELECTION



CPRC OUT DISPLAY TAG
[USER ENTERED TEXT]

 NOTE: Refer to **General Instrument Operation - Modifying Text** for information on this operation.

Definition: This text parameter defines the tag that is shown on the user display for the CPRC PID Control Output.

 TO ADVANCE TO NEXT SELECTION

CPRC OUT DECIMAL POS
[0 THROUGH 3]

 to change,   to choose,  to save

Definition: This parameter determines the active number of decimal places shown for the CPRC PID Control Output as shown on the user display.

 TO ADVANCE TO NEXT SELECTION

CPRC MANUAL ACTUATOR
 [NONE/OFF]
 [ON/CONTINUOUS]
 [ANY ALARM]
 [INSTRUMENT ALARM]
 [CHART FULL ALARM]
 [SFLR LOW SIGNAL ALARM]
 [SFLR HIGH RATE ALARM]
 [CHART RUN STATE]
 [DATA COLLECT STATE]
 [CONTROL ON STATE]
 [FWD FLOW ENABLED]
 [FWD FLOW REQUESTED]
 [STLR INPUT MISMATCH]
 [STLR OUT]
 [STLR ERR]
 [SFLR OUT]
 [SFLR ERR]
 [FLOW OUT]
 [FLOW ERR]
 [CPRC OUT]
 [CPRC ERR]
 [HWC OUT]
 [HWC ERR]
 [OP INP 1 OP INP 2]
 [OP INP 3 OP INP 4]
 [OP INP 5 OP INP 6]
 [OP INP 7 OP INP 8]
 [DA1 DA2 DA3 DA4]
 [DA5 DA6 DA7 DA8]
 [F1 F2 F3 F4 F5]
 [RESET MOD ENTER]

  to change,  or  to choose,   to save

Definition: This parameter selects the actuator, that when true, switches the CPRC PID Control to MANUAL mode, and when false, switches back to AUTOMATIC mode.

  TO ADVANCE TO NEXT SELECTION

CPRC CONTROL TUNING
[YES]
[NO]

 MOD to change,  or  to choose,  ENTER to save

Definition: This parameter determines if CPRC Controller PID tuning parameters are accessible while the unit is in RUN mode.

  TO ADVANCE TO NEXT SELECTION

CPRC SETPOINT CHANGE
[YES]
[NO]

 MOD to change,  or  to choose,  ENTER to save

Definition: This parameter determines if CPRC Controller PID Setpoint is accessible while the unit is in RUN mode.

  TO ADVANCE TO NEXT SELECTION







CPRC SP DISPLAY TAG
[USER ENTERED TEXT]

 NOTE: Refer to **General Instrument Operation - Modifying Text** for information on this operation.

Definition: This text parameter defines the tag that is shown on the user display for the CPRC PID Controller Setpoint..

  TO ADVANCE TO NEXT SELECTION







CPRC SP DECIMAL POSITION
[0 THROUGH 3]

  to change,   to choose,   to save

Definition: This parameter determines the active number of decimal places shown for the CPRC PID Control Setpoint as shown on the user display.

  TO ADVANCE TO NEXT SELECTION

CPRC NUMBER SETPOINTS
[0 THROUGH 1]

  to change,   to choose,   to save

Definition: This parameter determines whether the PID control is active or not. A “0” de-selects the controller, while a “1” will bring up the remainder of options.





 NOTE: Toggling this value will immediately move to the STLR menu system. Given we are making a change that may adversely affect the system, the user is reminded to verify the STLR setpoints before proceeding.

 NOTE: If option set to “0”, no menu choices present beyond this point.

  TO ADVANCE TO NEXT SELECTION

CPRC SP VALUE
[Y UNITS]

Y = Setpoint Value
Units = °F or °C as chosen in setup

 MOD to change,   to choose,  ENTER to save

Definition: This parameter defines the CPRC PID controller setpoint value.

 TO ADVANCE TO NEXT SELECTION

CPRC PROP. BAND
[Y UNITS]

Y = Proportional Band Value
Units = °F or °C as chosen in setup





 MOD to change,   to choose,  ENTER to save

Definition: This parameter defines the CPRC PID controller **Proportional Band** value.

 TO ADVANCE TO NEXT SELECTION

CPRC INTEG. BAND
[Y UNITS]

Y = Integration Value
Units = °F or °C as chosen in setup





 MOD to change,   to choose,  ENTER to save

Definition: This parameter provides the Integral value used in the PID control algorithm.

  TO ADVANCE TO NEXT SELECTION

CPRC AUTO RESET
[Y REPEATS/MIN]

Y = Auto Reset Value

 MOD to change,   to choose,  ENTER to save

Definition: This parameter provides an Automatic Reset value used by the PID algorithm.

  TO ADVANCE TO NEXT SELECTION



CPRC RATE
[Y MINUTES]

Y = Rate Value

 MOD to change,   to choose,  ENTER to save

Definition: This parameter provides a Rate value used by the PID algorithm.

  TO ADVANCE TO NEXT SELECTION

This completes CPRC Controller program options.   to return to main display, or  to return to start of **CONTROLLER MENU**.

6.3. Controller Setup Menu - HWC



The following section, HWC (Hot Water Controller), will illustrate the various programming options related to this function.

6.3.1. HWC Controller - ON/OFF- Shunt Position - PROGRAM MODE

While in the PROGRAM MODE, changes may be made to the HWC control related parameters. Access is gained as follows:

From the Normal Display, press the   key until the following is visible:

SELECT <->
CONTROLLER SETUP







With FUNCTION shown in the lower display line,   key. The following will now be visible on the user display:

CONTROL FUNCTION
STLR XXXX XXXX

 NOTE: XXXX will be vary depending on which options the unit has

  key until HWC is flashing,   key to select. Available parameters are:

HWC CONTROL TYPE
[DIRECT]
[REVERSE]

  to change,  or  to choose,   to save

Definition: This parameter selects the control action for the ON/OFF controller associated with the Hot Water.

Direct = Cooling
Reverse = Heating

  TO ADVANCE TO NEXT SELECTION

HWC OUT DISPLAY TAG
[USER ENTERED TEXT]



NOTE: Refer to **General Instrument Operation - Modifying Text** for information on this operation.

Definition: This text parameter defines the tag that is shown on the user display for the HWC ON/OFF control output.



TO ADVANCE TO NEXT SELECTION

HWC CONTROL TUNING
[YES]
[NO]



to change,



or



to choose,



to save

Definition: This parameter determines if HWC controller ON/OFF tuning parameters are accessible while the unit is in RUN mode.



TO ADVANCE TO NEXT SELECTION

HWC SETPOINT CHANGE
[YES]
[NO]



to change,



or



to choose,



to save

Definition: This parameter determines if HWC controller ON/OFF setpoint is accessible while the unit is in RUN mode.



TO ADVANCE TO NEXT SELECTION





HWC SP DISPLAY TAG
[USER ENTERED TEXT]

 NOTE: Refer to **General Instrument Operation - Modifying Text** for information on this operation.

Definition: This text parameter defines the tag that is shown on the user display for the HWC ON/OFF setpoint..

 TO ADVANCE TO NEXT SELECTION

HWC SP DECIMAL POSITION
[0 THROUGH 3]

 MOD to change,   to choose,  ENTER to save

Definition: This parameter determines the active number of decimal places shown for the HWC ON/OFF setpoint as shown on the user display.

 TO ADVANCE TO NEXT SELECTION

HWC NUMBER SETPOINTS
[0 THROUGH 1]

 MOD to change,   to choose,  ENTER to save

Definition: This parameter determines whether the ON/OFF control is active or not. A “0” de-selects the controller, while a “1” will bring up the remainder of options.





 NOTE: Toggling this value will immediately move to the STLR menu system. Given we are making a change that may adversely affect the system, the user is reminded to verify the STLR setpoints before proceeding.

 NOTE: If option set to “0”, no menu choices present beyond this point.

 TO ADVANCE TO NEXT SELECTION

HWC SP1 VALUE
[Y UNITS]

Y = Setpoint Value
Units = °F or °C as chosen in setup



  to change,   to choose,   to save

Definition: This parameter defines the HWC ON/OFF setpoint value.

  TO ADVANCE TO NEXT SELECTION



HWC SP1 HYSTERESIS
[Y UNITS]

Y = Proportional Band Value
Units = °F or °C as chosen in setup

  to change,   to choose,   to save

Definition: This parameter defines the HWC ON/OFF hysteresis (deadband) value.

  TO ADVANCE TO NEXT SELECTION



This completes HWC ON/OFF control program options -   to return to main display, or  to return to start of **CONTROLLER SETUP MENU**.

6.3.2. HWC Controller - PID - Shunt Position - PROGRAM MODE

While in the PROGRAM MODE, changes may be made to the HWC control related parameters. Access is gained as follows:

From the Normal Display, press the   key until the following is visible:

```
SELECT <->
CONTROLLER SETUP
```





With FUNCTION shown in the lower display line,   key. The following will now be visible on the user display:

```
CONTROL FUNCTION
STLR XXXX XXXX
```

 NOTE: XXXX will be vary depending on which options the unit has

  key until HWC is flashing,   key to select. Available parameters are:

```
HWC CONTROL TYPE
[DIRECT]
[REVERSE]
```





  to change,  or  to choose,   to save

Definition: This parameter selects the control action for the PID Controller associated with the Hot Water.

Direct = Cooling
Reverse = Heating

  TO ADVANCE TO NEXT SELECTION





HWC OUT UPPER LIMIT
[1 THROUGH 100 %]

 **MOD** to change,   to choose,  **ENTER** to save

Definition: This parameter establishes a maximum limit for the HWC PID controller mA output.

  TO ADVANCE TO NEXT SELECTION





HWC OUT % ON ERROR
[0 THROUGH 100 %]

 **MOD** to change,   to choose,  **ENTER** to save

Definition: In the event of an error condition, the controller output may be forced to a percentage of signal. This will ensure a safe condition during the error period. (Ex: Air-To-Open valve, 0% will ensure valve stays closed)

  TO ADVANCE TO NEXT SELECTION

HWC OUT SLEW RATE
[%/MIN]

 **MOD** to change,   to choose,  **ENTER** to save

Definition: This parameter establishes the Slew Rate for the Hot Water PID controller. It's function is to force the controller output to slowly ramp to avoid a rapid start-up. (Ex. 60%/MIN = 1% per Second)

  TO ADVANCE TO NEXT SELECTION



HWC OUT DISPLAY TAG
[USER ENTERED TEXT]

 NOTE: Refer to **General Instrument Operation - Modifying Text** for information on this operation.

Definition: This text parameter defines the tag that is shown on the user display for the HWC PID control output.

 TO ADVANCE TO NEXT SELECTION





HWC OUT DECIMAL POS
[0 THROUGH 3]

 to change,   to choose,  to save

Definition: This parameter determines the active number of decimal places shown for the HWC PID control output as shown on the user display.

 TO ADVANCE TO NEXT SELECTION

HWC MANUAL ACTUATOR
 [NONE/OFF]
 [ON/CONTINUOUS]
 [ANY ALARM]
 [INSTRUMENT ALARM]
 [CHART FULL ALARM]
 [SFLR LOW SIGNAL ALARM]
 [SFLR HIGH RATE ALARM]
 [CHART RUN STATE]
 [DATA COLLECT STATE]
 [CONTROL ON STATE]
 [FWD FLOW ENABLED]
 [FWD FLOW REQUESTED]
 [STLR INPUT MISMATCH]
 [STLR OUT]
 [STLR ERR]
 [SFLR OUT]
 [SFLR ERR]
 [FLOW OUT]
 [FLOW ERR]
 [CPRC OUT]
 [CPRC ERR]
 [HWC OUT]
 [HWC ERR]
 [OP INP 1 OP INP 2]
 [OP INP 3 OP INP 4]
 [OP INP 5 OP INP 6]
 [OP INP 7 OP INP 8]
 [DA1 DA2 DA3 DA4]
 [DA5 DA6 DA7 DA8]
 [F1 F2 F3 F4 F5]
 [RESET MOD ENTER]

 to change,  or  to choose,  to save

Definition: This parameter selects the actuator, that when true, switches the HWC PID control to MANUAL mode, and when false, switches back to AUTOMATIC mode.

 TO ADVANCE TO NEXT SELECTION





HWC CONTROL TUNING
[YES]
[NO]

 MOD to change,  or  to choose,  ENTER to save

Definition: This parameter determines if HWC controller PID tuning parameters are accessible while the unit is in RUN mode.

  TO ADVANCE TO NEXT SELECTION

HWC SETPOINT CHANGE
[YES]
[NO]

 MOD to change,  or  to choose,  ENTER to save

Definition: This parameter determines if HWC controller PID setpoint is accessible while the unit is in RUN mode.

  TO ADVANCE TO NEXT SELECTION





HWC SP DISPLAY TAG
[USER ENTERED TEXT]

 NOTE: Refer to **General Instrument Operation - Modifying Text** for information on this operation.

Definition: This text parameter defines the tag that is shown on the user display for the HWC PID controller setpoint..

  TO ADVANCE TO NEXT SELECTION





HWC SP DECIMAL POSITION
[0 THROUGH 3]

 to change,   to choose,  to save

Definition: This parameter determines the active number of decimal places shown for the HWC PID control setpoint as shown on the user display.

 TO ADVANCE TO NEXT SELECTION

HWC NUMBER SETPOINTS
[0 THROUGH 1]

 to change,   to choose,  to save

Definition: This parameter determines whether the PID control is active or not. A “0” de-selects the controller, while a “1” will bring up the remainder of options.







 NOTE: Toggling this value will immediately move to the STLR menu system. Given we are making a change that may adversely affect the system, the user is reminded to verify the STLR setpoints before proceeding.

 NOTE: If option set to “0”, no menu choices present beyond this point.

 TO ADVANCE TO NEXT SELECTION

HWC SP VALUE
[Y UNITS]

Y = Setpoint Value
Units = °F or °C as chosen in setup

  to change,   to choose,   to save

Definition: This parameter defines the HWC PID controller setpoint value.

  TO ADVANCE TO NEXT SELECTION

HWC PROP. BAND
[Y UNITS]

Y = Proportional Band Value
Units = °F or °C as chosen in setup







  to change,   to choose,   to save

Definition: This parameter defines the HWC PID controller Proportional Band value.

  TO ADVANCE TO NEXT SELECTION

HWC INTEG. BAND
[Y UNITS]

Y = Integration Value
Units = °F or °C as chosen in setup







  to change,   to choose,   to save

Definition: This parameter provides the Integral value used in the PID control algorithm.

  TO ADVANCE TO NEXT SELECTION

HWC AUTO RESET
[Y REPEATS/MIN]

Y = Auto Reset Value

  to change,   to choose,   to save

Definition: This parameter provides an Automatic Reset value used by the PID algorithm.

  TO ADVANCE TO NEXT SELECTION

HWC RATE
[Y MINUTES]

Y = Rate Value

  to change,   to choose,   to save

Definition: This parameter provides a Rate value used by the PID algorithm.

  TO ADVANCE TO NEXT SELECTION

This completes HWC controller program options -   to return to main display, or  to return to start of **CONTROLLER MENU**.

6.4. Controller Setup Menu - SFLR

The following section, SFLR (Safety Flow Limit Recorder), will illustrate the various programming options related to this function.



 NOTE: Options exist for both ON/OFF and PID methods of control. Before proceeding with changes, be sure to determine the current method of operation. Settings may be viewed in the **SFLR Function Setup Menu**.

6.4.1. SFLR Controller - ON/OFF- Shunt Position - PROGRAM MODE

While in the PROGRAM MODE, changes may be made to the SFLR Control related parameters. Access is gained as follows:

From the Normal Display, press the   key until the following is visible:

SELECT <->
CONTROLLER SETUP

With FUNCTION shown in the lower display line,   key. The following will now be visible on the user display:

CONTROL FUNCTION
STLR XXXX XXXX

 NOTE: XXXX will vary depending on which options the unit has

  key until SFLR is flashing,   key to select. Available parameters are:

SFLR CONTROL TYPE
[DIRECT]
[REVERSE]

  to change,  or  to choose,   to save

Definition: This parameter selects the control action for the ON/OFF Controller associated with the Cold Product.

Direct = Cooling
Reverse = Heating

  TO ADVANCE TO NEXT SELECTION

SFLR OUT DISPLAY TAG
[USER ENTERED TEXT]

 NOTE: Refer to **General Instrument Operation - Modifying Text** for information on this operation.

Definition: This text parameter defines the tag that is shown on the user display for the SFLR ON/OFF Control Output.

 TO ADVANCE TO NEXT SELECTION

SFLR CONTROL TUNING
[YES]
[NO]

 to change,  or  to choose,  to save

Definition: This parameter determines if SFLR Controller ON/OFF tuning parameters are accessible while the unit is in RUN mode.

 TO ADVANCE TO NEXT SELECTION

SFLR SETPOINT CHANGE
[YES]
[NO]

 to change,  or  to choose,  to save

Definition: This parameter determines if SFLR Controller ON/OFF Setpoint is accessible while the unit is in RUN mode.

 TO ADVANCE TO NEXT SELECTION



SFLR SP DISPLAY TAG
[USER ENTERED TEXT]

 NOTE: Refer to **General Instrument Operation - Modifying Text** for information on this operation.

Definition: This text parameter defines the tag that is shown on the user display for the SFLR ON/OFF Setpoint..

 TO ADVANCE TO NEXT SELECTION

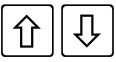
SFLR SP DECIMAL POSITION
[0 THROUGH 3]

 to change,  to choose,  to save

Definition: This parameter determines the active number of decimal places shown for the SFLR ON/OFF Setpoint as shown on the user display.

 TO ADVANCE TO NEXT SELECTION

SFLR NUMBER SETPOINTS
[0 THROUGH 1]

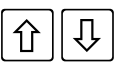
 to change,  to choose,  to save

Definition: This parameter determines whether the ON/OFF control is active or not. A “0” de-selects the controller, while a “1” will bring up the remainder of options.





 NOTE: Toggling this value will immediately move to the STLR menu system. Given we are making a change that may adversely affect the system, the user is reminded to verify the STLR setpoints before proceeding.

 NOTE: If option set to “0”, no menu choices present beyond this point.

 TO ADVANCE TO NEXT SELECTION

SFLR SP VALUE
[Y UNITS]

Y = Setpoint Value
Units = As chosen in setup





 to change,   to choose,  to save

Definition: This parameter defines the SFLR ON/OFF Setpoint value.

 TO ADVANCE TO NEXT SELECTION

SFLR HYSTERESIS
[Y UNITS]

Y = Proportional Band Value
Units = °F or °C as chosen in setup

 to change,   to choose,  to save

Definition: This parameter defines the SFLR ON/OFF Hysteresis (deadband) value.

 TO ADVANCE TO NEXT SELECTION

This completes SFLR ON/OFF control program options -  to return to main display, or



 to return to start of **CONTROLLER MENU**.

6.4.2. SFLR Controller - PID - Shunt Position - PROGRAM MODE

While in the PROGRAM MODE, changes may be made to the SFLR Control related parameters. Access is gained as follows:

From the Normal Display, press the   key until the following is visible:

```
SELECT      <->
CONTROLLER SETUP
```

With FUNCTION shown in the lower display line,   key. The following will now be visible on the user display:

```
CONTROL FUNCTION
STLR   XXXX   XXXX
```

 NOTE: XXXX will be vary depending on which options the unit has

  key until SFLR is flashing,   key to select. Available parameters are:





```
SFLR CONTROL TYPE
[DIRECT]
[REVERSE]
```

  to change,  or  to choose,   to save

Definition: This parameter selects the control action for the PID Controller associated with the Safety Flow.

  TO ADVANCE TO NEXT SELECTION

SFLR OUT UPPER LIMIT
[1 THROUGH 100 %]

 **MOD** to change,   to choose,  **ENTER** to save

Definition: This parameter establishes a maximum limit for the SFLR PID Controller mA output.

  TO ADVANCE TO NEXT SELECTION

SFLR OUT % ON ERROR
[0 THROUGH 100 %]

 **MOD** to change,   to choose,  **ENTER** to save

Definition: In the event of an error condition, the Controller Output may be forced to a percentage of signal. This will ensure a safe condition during the error period. (Ex: Air-To-Open valve, 0% will ensure valve stays closed)

  TO ADVANCE TO NEXT SELECTION

SFLR OUT SLEW RATE
[%/MIN]

 **MOD** to change,   to choose,  **ENTER** to save

Definition: This parameter establishes the Slew Rate for the Safety Flow PID Controller. It's function is to force the controller output to slowly ramp to avoid a rapid start-up. (Ex. 60%/MIN = 1% per Second)

  TO ADVANCE TO NEXT SELECTION



SFLR OUT DISPLAY TAG
[USER ENTERED TEXT]

 NOTE: Refer to **General Instrument Operation - Modifying Text** for information on this operation.

Definition: This text parameter defines the tag that is shown on the user display for the SFLR PID Control Output.

 TO ADVANCE TO NEXT SELECTION

SFLR OUT DECIMAL POS
[0 THROUGH 3]

 to change,   to choose,  to save

Definition: This parameter determines the active number of decimal places shown for the SFLR PID Control Output as shown on the user display.

 TO ADVANCE TO NEXT SELECTION

SFLR MANUAL ACTUATOR
 [NONE/OFF]
 [ON/CONTINUOUS]
 [ANY ALARM]
 [INSTRUMENT ALARM]
 [CHART FULL ALARM]
 [SFLR LOW SIGNAL ALARM]
 [SFLR HIGH RATE ALARM]
 [CHART RUN STATE]
 [DATA COLLECT STATE]
 [CONTROL ON STATE]
 [FWD FLOW ENABLED]
 [FWD FLOW REQUESTED]
 [STLR INPUT MISMATCH]
 [STLR OUT]
 [STLR ERR]
 [SFLR OUT]
 [SFLR ERR]
 [FLOW OUT]
 [FLOW ERR]
 [CPRC OUT]
 [CPRC ERR]
 [HWC OUT]
 [HWC ERR]
 [OP INP 1 OP INP 2]
 [OP INP 3 OP INP 4]
 [OP INP 5 OP INP 6]
 [OP INP 7 OP INP 8]
 [DA1 DA2 DA3 DA4]
 [DA5 DA6 DA7 DA8]
 [F1 F2 F3 F4 F5]
 [RESET MOD ENTER]





 to change,  or  to choose,  to save

Definition: This parameter selects the actuator, that when true, switches the SFLR PID Control to MANUAL mode, and when false, switches back to AUTOMATIC mode.

Default: OP INP 3 (Do not modify)

 TO ADVANCE TO NEXT SELECTION

SFLR CONTROL TUNING
[YES]
[NO]

 MOD to change,  or  to choose,  ENTER to save

Definition: This parameter determines if SFLR Controller PID tuning parameters are accessible while the unit is in RUN mode.

  TO ADVANCE TO NEXT SELECTION

SFLR SETPOINT CHANGE
[YES]
[NO]

 MOD to change,  or  to choose,  ENTER to save

Definition: This parameter determines if SFLR Controller PID Setpoint is accessible while the unit is in RUN mode.

  TO ADVANCE TO NEXT SELECTION







SFLR SP DISPLAY TAG
[USER ENTERED TEXT]

 NOTE: Refer to **General Instrument Operation - Modifying Text** for information on this operation.

Definition: This text parameter defines the tag that is shown on the user display for the SFLR PID Controller Setpoint..

  TO ADVANCE TO NEXT SELECTION







SFLR SP DECIMAL POSITION
[0 THROUGH 3]

  to change,   to choose,   to save

Definition: This parameter determines the active number of decimal places shown for the SFLR PID Control Setpoint as shown on the user display.

  TO ADVANCE TO NEXT SELECTION

SFLR NUMBER SETPOINTS
[0 THROUGH 1]

  to change,   to choose,   to save

Definition: This parameter determines whether the PID control is active or not. A “0” de-selects the controller, while a “1” will bring up the remainder of options.





 NOTE: Toggling this value will immediately move to the STLR menu system. Given we are making a change that may adversely affect the system, the user is reminded to verify the STLR setpoints before proceeding.

 NOTE: If option set to “0”, no menu choices present beyond this point.

  TO ADVANCE TO NEXT SELECTION

SFLR SP VALUE
[Y UNITS]

Y = Setpoint Value
Units = As chosen in setup



 MOD to change,   to choose,  ENTER to save

Definition: This parameter defines the SFLR PID controller setpoint value.

  TO ADVANCE TO NEXT SELECTION

SFLR PROP. BAND
[Y UNITS]

Y = Proportional Band Value
Units = As chosen in setup





 MOD to change,   to choose,  ENTER to save

Definition: This parameter defines the SFLR PID controller **Proportional Band** value.

  TO ADVANCE TO NEXT SELECTION

SFLR INTEG. BAND
[Y UNITS]

Y = Integration Value
Units = °F or °C as chosen in setup







 MOD to change,   to choose,  ENTER to save

Definition: This parameter provides the Integral value used in the PID control algorithm.

  TO ADVANCE TO NEXT SELECTION

SFLR AUTO RESET
[Y REPEATS/MIN]

Y = Auto Reset Value







  to change,   to choose,   to save

Definition: This parameter provides an Automatic Reset value used by the PID algorithm.

  TO ADVANCE TO NEXT SELECTION



SFLR RATE
[Y MINUTES]

Y = Rate Value

  to change,   to choose,   to save

Definition: This parameter provides a Rate value used by the PID algorithm.

  TO ADVANCE TO NEXT SELECTION

This completes SFLR Controller program options -   to return to main display, or  to return to start of **CONTROLLER MENU**.

7. Program Reference - Configuration Menu

 CAUTION: Unless otherwise specified, the model AV-9900 HTST will be provided pre-programmed from the Factory. Prior to making modifications, it is recommended that you record current settings.

7.1. Configuration Menu - Instrument Settings



7.1.1. Instrument Settings - Shunt Position - RUN MODE

While in the RUN MODE, changes may be made to parameters which affect the Instrument operation. All parameters may not be accessible, as many are dependent on activation by another parameter. Access is gained as follows:



 Note: Refer to General Instrument Operations section for instructions on identifying RUN and PROGRAM mode of operation.

From the Normal Display,   key until the following is visible:

```
SELECT <->
CONFIGURATION
```

With CONFIGURATION shown in the lower display line,   key. The following will now be visible on the user display:

```
CONFIGURE <->
INSTRUMENT SETTINGS
```

With INSTRUMENT SETTINGS shown in the lower display line,   key. Available parameters are:





```
TAG DISPLAY OPTION
[NOT DISPLAYED]
[IN CONTINUOUS MODE]
[IN SEQUENTIAL MODE]
[IN BOTH MODES]
```





  to change,   to choose,   to save





Definition: This parameter selects which display modes will allow the Instrument Tag to be displayed. The Instrument Tag is a user entered string which may be viewed on the display.

 TO ADVANCE TO NEXT SELECTION

CURRENT DATE
MM/DD/YY XX/XX/XX

 to change,   to choose Month,  to save





 to change,   to choose Day,  to save





 to change,   to choose Year,  to save





Definition: This parameter allows setting the current date.

 TO ADVANCE TO NEXT SELECTION

CURRENT TIME
AM/PM XX:XX XX

 to change,   to choose Hour,  to save

 to change,   to choose Minutes,  to save

 to change,   to choose AM/PM,  to save

Definition: This parameter allows setting the current time.

 TO ADVANCE TO NEXT SELECTION

This completes Instrument Settings program options,  to return to main display.



7.1.2. Instrument Settings - Shunt Position - PROGRAM MODE

While in the PROGRAM MODE, changes may be made to parameters which affect the Instrument operation. All parameters may not be accessible, as many are dependent on activation by another parameter. Access is gained as follows:



 Note: Refer to General Instrument Operations section for instructions on identifying RUN and PROGRAM mode of operation.

From the Normal Display,   key until the following is visible:

SELECT <->
CONFIGURATION

With CONFIGURATION shown in the lower display line,   key. The following will now be visible on the user display:

CONFIGURE <->
INSTRUMENT SETTINGS

With INSTRUMENT SETTINGS shown in the lower display line,   key. Available parameters are:





INSTRUMENT TAG
[USER ENTERED TEXT]

 NOTE: Refer to **General Instrument Operation - Modifying Text** for information on this operation.

Definition: This text parameter defines the Instrument Tag that is shown on the user display.

  TO ADVANCE TO NEXT SELECTION

TAG DISPLAY OPTION
[NOT DISPLAYED]
[IN CONTINUOUS MODE]
[IN SEQUENTIAL MODE]
[IN BOTH MODES]

 MOD to change,   to choose,  ENTER to save

Definition: This parameter selects which display modes will allow the Instrument Tag to be displayed. The Instrument Tag is a user entered string which may be viewed on the display.

  TO ADVANCE TO NEXT SELECTION

TEMPERATURE UNITS
°X

 MOD to change,   to choose,  ENTER to save

Definition: This parameter selects units of operation, °F or °C , for all recorder functions.

  TO ADVANCE TO NEXT SELECTION



DATE DISPLAY FORMAT
XXXXXXXX

 MOD to change,   to choose,  ENTER to save

Definition: This parameter selects format for date display.

  TO ADVANCE TO NEXT SELECTION





TIME DISPLAY FORMAT
XXXXXXXX





 MOD to change,  to choose,  ENTER to save

Definition: This parameter selects format for date display.

 TO ADVANCE TO NEXT SELECTION

CURRENT DATE
MM/DD/YY XX/XX/XX

 MOD to change,   to choose Month,  ENTER to save





 MOD to change,   to choose Day,  ENTER to save





 MOD to change,   to choose Year,  ENTER to save





Definition: This parameter allows setting the current date.

 TO ADVANCE TO NEXT SELECTION

CURRENT TIME
AM/PM XX:XX XX

 MOD to change,   to choose Hour,  ENTER to save







 MOD to change,   to choose Minutes,  ENTER to save

 MOD to change,   to choose AM/PM,  ENTER to save

Definition: This parameter allows setting the current time.

 TO ADVANCE TO NEXT SELECTION

COMMS ADDRESS
X

  to change,   to choose,   to save

Definition: This parameter selects active communications port.

NOTE: Not available for use in field applications.

  TO ADVANCE TO NEXT SELECTION

COMMS BIT RATE
[1200]
[2400]
[4800]
[9600]

  to change,   to choose,   to save

Definition: This parameter selects communications bit rate.

NOTE: Not available for use in field applications.

  TO ADVANCE TO NEXT SELECTION



COMMS PARITY
[ODD]
[EVEN]
[NONE]

  to change,   to choose,   to save

Definition: This parameter selects communications bit rate.

NOTE: Not available for use in field applications.

  TO ADVANCE TO NEXT SELECTION

This completes Instrument Settings program options,   to return to main display.

7.2. Configuration Menu - Inputs

7.2.1. Inputs - Shunt Position - PROGRAM MODE





While in the PROGRAM MODE, changes may be made to parameters which affect the AV-9900 input selections. All parameters may not be accessible, as many are dependent on activation by another parameter or option. Access is gained as follows:

 Note: This programming menu is NOT available for modification while unit is in the RUN mode of operation.



 Note: Refer to General Instrument Operations section for instructions on identifying RUN and PROGRAM mode of operation.





From the Normal Display,   key until the following is visible:



```
SELECT    <->
CONFIGURATION
```

With CONFIGURATION shown in the lower display line,   key.   until the following is visible on the user display:

```
CONFIGURE    <->
INPUTS
```

With INPUTS shown in the lower display line,   key. Depending on the instrument configuration, STLR, SFLR, CPRC and HWC input choices may be present.

  until desired choice is flashing, then   to enter appropriate section.

Upon viewing all parameters for a selected input, the menu will continue to scroll to the next parameter.   to exit and return to the main system display. Available parameters are:

INPUT FUNCTION
STLR

Start of menu options for STLR input programming.



STLR INP DISPLAY TAG
[USER ENTERED TEXT]

 NOTE: Refer to **General Instrument Operation - Modifying Text** for information on this operation.

Definition: This text parameter defines the STLR Input Tag that is shown on the user display.

 TO ADVANCE TO NEXT SELECTION

STLR INP DECIMAL POS
X



 to change,   to choose,  to save

Definition: This parameter selects active decimal places for the STLR user display.

 TO ADVANCE TO NEXT SELECTION

STLR INP LIMIT LOW
X

 NOTE: Factory default parameter - value should remain at “0”





 to change,   to choose,  to save

Definition: This parameter selects low input range for the STLR input.

 TO ADVANCE TO NEXT SELECTION

STLR INP LIMIT HIGH
X

 NOTE: Factory default parameter - value should remain at “350”





 MOD to change,   to choose,  ENTER to save





Definition: This parameter selects high input range for the STLR input.

 TO ADVANCE TO NEXT SELECTION

STLR INPUT 1 CORR 1
X AT X

 NOTE: This parameter is documented in Instrument Maintenance - Two Point Hot Product Probe Calibration

 MOD to change value,   to choose,  ENTER to save





 MOD to change correction,   to choose,  ENTER to save





Definition: This is a correction parameter used for the low end of the primary element in the Hot Product probe.

 TO ADVANCE TO NEXT SELECTION

STLR INPUT 1 CORR 2
X AT X

 NOTE: This parameter is documented in Instrument Maintenance - Two Point Hot Product Probe Calibration.

 MOD to change value,   to choose,  ENTER to save





 MOD to change correction,   to choose,  ENTER to save





Definition: This is a correction parameter used for the high end of the primary element in the Hot Product probe.

 TO ADVANCE TO NEXT SELECTION

STLR INPUT 2 CORR 1
X AT X

 NOTE: This parameter is documented in Instrument Maintenance - Two Point Hot Product Probe Calibration.

 MOD to change value,   to choose,  ENTER to save





 MOD to change correction,   to choose,  ENTER to save





Definition: This is a correction parameter used for the low end of the secondary element in the Hot Product probe.

 TO ADVANCE TO NEXT SELECTION

STLR INPUT 2 CORR 2
X AT X

 NOTE: This parameter is documented in Instrument Maintenance - Two Point Hot Product Probe Calibration.



 MOD to change value,   to choose,  ENTER to save

 MOD to change correction,   to choose,  ENTER to save

Definition: This is a correction parameter used for the high end of the secondary element in the Hot Product probe.

 TO ADVANCE TO NEXT SELECTION

This completes the STLR Input setup menus.   to return to the normal display, or

  to continue to the next input selection.

INPUT FUNCTION
SFLR

Start of menu options for SFLR input programming.

SFLR INP DISPLAY TAG
[USER ENTERED TEXT]

 NOTE: Refer to **General Instrument Operation - Modifying Text** for information on this operation.

Definition: This text parameter defines the SFLR Input Tag that is shown on the user display.

  TO ADVANCE TO NEXT SELECTION

SFLR INP DECIMAL POS
X

  to change,   to choose,   to save

Definition: This parameter selects active decimal places for the SFLR user display.

  TO ADVANCE TO NEXT SELECTION

SFLR INP RANGE LOW
X

  to change,   to choose,   to save

Definition: This parameter selects low input range for the SFLR input. Typical setting is 4.00 mA. MUST match output of flowmeter.

 TO ADVANCE TO NEXT SELECTION

SFLR INP RANGE HIGH
X

 to change,   to choose,  to save

Definition: This parameter selects high input range for the SFLR input. Typical setting is 20.00 mA. MUST match output of flowmeter.

 TO ADVANCE TO NEXT SELECTION

SFLR INP LIMIT LOW
X

 to change,   to choose,  to save

Definition: This parameter selects low limit for the SFLR input. This setting is in units, as determined in Function Setup. Be sure setting equals flow rate at Range Low parameter.

 TO ADVANCE TO NEXT SELECTION

SFLR INP LIMIT HIGH
X









 to change,   to choose,  to save

Definition: This parameter selects high limit for the SFLR input. This setting is in units, as determined in Function Setup. Be sure setting equals flow rate at Range High parameter.

 TO ADVANCE TO NEXT SELECTION

SFLR INPUT 1 CORR 1
X AT X

 NOTE: This parameter is documented in Instrument Maintenance - SFLR Input Calibration.









 MOD to change value,   to choose,  ENTER to save
 MOD to change correction,   to choose,  ENTER to save

Definition: This is a correction parameter used for the low end of the SFLR input.

  TO ADVANCE TO NEXT SELECTION

SFLR INPUT 1 CORR 2
X AT X



 NOTE: This parameter is documented in Instrument Maintenance - SFLR Input Calibration.

 MOD to change value,   to choose,  ENTER to save
 MOD to change correction,   to choose,  ENTER to save

Definition: This is a correction parameter used for the high end of the SFLR input.

  TO ADVANCE TO NEXT SELECTION

This completes the SFLR Input setup menus.   to return to the normal display, or

  to continue to the next input selection.

INPUT FUNCTION
CPRC

Start of menu options for CPRC input programming.

CPRC INPUT TYPE
[RTD]
[Ma]

  to change,   to choose,   to save

Definition: This parameter selects the CPRC input type.

  TO ADVANCE TO NEXT SELECTION

CPRC INP RTD TYPE
[PT 100 .00385 DIN]
[PT 100 .00392 USA]
[PT 100 .00392 SAMA]
[NI 100]

 NOTE: Shown ONLY if input type is RTD.

  to change,   to choose,   to save

Definition: This parameter selects the CPRC input type.

  TO ADVANCE TO NEXT SELECTION

CPRC INP DISPLAY TAG







[USER ENTERED TEXT]

 NOTE: Refer to **General Instrument Operation - Modifying Text** for information on this operation.

Definition: This text parameter defines the CPRC Input Tag that is shown on the user display.

  TO ADVANCE TO NEXT SELECTION

CPRC INP DECIMAL POS
X

  to change,   to choose,   to save

Definition: This parameter selects active decimal places for the CPRC user display.

  TO ADVANCE TO NEXT SELECTION

CPRC INP RANGE LOW
X

 NOTE: Not shown if input type RTD.

Definition: This parameter selects low input range for the CPRC input. Typical setting is 4.00 mA. MUST match output of sensor.

  TO ADVANCE TO NEXT SELECTION

CPRC INP RANGE HIGH
X

 NOTE: Not shown if input type RTD.

Definition: This parameter selects high input range for the CPRC input. Typical setting is 20.00 mA. MUST match output of sensor.

 TO ADVANCE TO NEXT SELECTION

CPRC INP LIMIT LOW
X

Definition: This parameter selects low limit for the CPRC input. This is a factory default setting.

 TO ADVANCE TO NEXT SELECTION





CPRC INP LIMIT HIGH
X





Definition: This parameter selects high limit for the CPRC input. This is a factory default setting.

 TO ADVANCE TO NEXT SELECTION

CPRC INPUT 1 CORR 1
X AT X

 NOTE: This parameter is documented in Instrument Maintenance - CPRC Input Calibration.

 to change value,   to choose,  to save

 to change correction,   to choose,  to save

Definition: This is a correction parameter used for the low end of the CPRC input.

 TO ADVANCE TO NEXT SELECTION

CPRC INPUT 1 CORR 2
X AT X



NOTE: This parameter is documented in Instrument Maintenance - CPRC Input Calibration.

MOD to change value, to choose, ENTER to save
 MOD to change correction, to choose, ENTER to save

Definition: This is a correction parameter used for the high end of the CPRC input.



TO ADVANCE TO NEXT SELECTION

This completes the CPRC Input setup menus. RESET to return to the normal display, or



to continue to the next input selection.

INPUT FUNCTION
HWC

Start of menu options for CPRC input programming.

HWC INPUT TYPE
[RTD]
[Ma]

MOD to change, to choose, ENTER to save

Definition: This parameter selects the HWC input type.



TO ADVANCE TO NEXT SELECTION

HWC INP RTD TYPE
[PT 100 .00385 DIN]
[PT 100 .00392 USA]
[PT 100 .00392 SAMA]
[NI 100]

 NOTE: Shown ONLY if input type is RTD.

  to change,   to choose,   to save

Definition: This parameter selects the HWC input type.

  TO ADVANCE TO NEXT SELECTION







HWC INP DISPLAY TAG
[USER ENTERED TEXT]

 NOTE: Refer to **General Instrument Operation - Modifying Text** for information on this operation.

Definition: This text parameter defines the HWC Input Tag that is shown on the user display.

  TO ADVANCE TO NEXT SELECTION

HWC INP DECIMAL POS
X

  to change,   to choose,   to save

Definition: This parameter selects active decimal places for the HWC user display.

  TO ADVANCE TO NEXT SELECTION

HWC INP RANGE LOW
X

 NOTE: Not shown if input type RTD.

Definition: This parameter selects low input range for the HWC input. Typical setting is 4.00 mA. MUST match output of sensor.



TO ADVANCE TO NEXT SELECTION

HWC INP RANGE HIGH
X



NOTE: Not shown if input type RTD.

Definition: This parameter selects high input range for the HWC input. Typical setting is 20.00 mA. MUST match output of sensor.



TO ADVANCE TO NEXT SELECTION

HWC INP LIMIT LOW
X

Definition: This parameter selects low limit for the HWC input. This is a factory default setting.



TO ADVANCE TO NEXT SELECTION

HWC INP LIMIT HIGH
X













Definition: This parameter selects high limit for the HWC input. This is a factory default setting.



TO ADVANCE TO NEXT SELECTION

HWC INPUT 1 CORR 1
X AT X

 NOTE: This parameter is documented in Instrument Maintenance - HWC Input Calibration.













  to change value,   to choose,   to save
  to change correction,   to choose,   to save

Definition: This is a correction parameter used for the low end of the HWC input.

  TO ADVANCE TO NEXT SELECTION



HWC INPUT 1 CORR 2
X AT X



 NOTE: This parameter is documented in Instrument Maintenance - HWC Input Calibration.

  to change value,   to choose,   to save
  to change correction,   to choose,   to save

Definition: This is a correction parameter used for the high end of the HWC input.

  TO ADVANCE TO NEXT SELECTION

This completes the HWC Input setup menus.   to return to the normal display, or

  to continue to the next input selection.

7.3. Configuration Menu - Simulated Inputs

Simulated Inputs may be used for demonstration purposes. When active, a valid input to the AV-9900 is not required. Activation is done in the Function Setup Menu under Input Usage (NORMAL or SIMULATED).

7.3.1. Simulated Inputs - Shunt Position - RUN MODE

No programming access is allowed under the RUN mode.





7.3.2. Simulated Inputs - Shunt Position - PROGRAM MODE

While in the PROGRAM MODE, changes may be made to parameters which affect the simulated inputs. All parameters may not be accessible, as many are dependent on activation by another parameter. Access is gained as follows:



 Note: Refer to General Instrument Operations section for instructions on identifying RUN and PROGRAM mode of operation.





From the Normal Display,   key until the following is visible:





```
SELECT      <->
CONFIGURATION
```

With CONFIGURATION shown in the lower display line,   key.   until the following is visible on the user display:

```
CONFIGURE   <->
SIMULATED INPUTS
```

With SIMULATED INPUTS shown in the lower display line,   key.

  to choose desired simulated variable,   to begin programming.

Once all parameters for a specific simulated variable have been programmed, the unit will automatically scroll to the next available function (STLR, SFLR, CPRC or HWC).   will return to the normal display, or   will continue to advance through the next parameter set. Available parameters are:

STLR SIM SELECTION
[PRIMARY]
[SECONDARY]

  to change,   to choose,   to save

Definition: This parameter selects start of simulated input setup - either Primary or Secondary simulation.

  TO ADVANCE TO NEXT SELECTION





STLR SIP TYPE
[OFF - NO INPUT]
[SINE WAVE]
[SAWTOOTH]
[SQUARE WAVE]
[SPIKES]

  to change,   to choose,   to save

Definition: This parameter selects the type of PRIMARY simulated input.

  TO ADVANCE TO NEXT SELECTION

STLR SIP DECIMAL POS
X

 to change,   to choose,  to save

Definition: This parameter selects number of decimal places to be used for PRIMARY simulated input.

 TO ADVANCE TO NEXT SELECTION

STLR SIP DISPLAY TAG
[USER ENTERED TEXT]

 NOTE: Refer to **General Instrument Operation - Modifying Text** for information on this operation.

Definition: This text parameter defines the STLR PRIMARY SIP tag that is shown on the user display.

 TO ADVANCE TO NEXT SELECTION





STLR SIP RANGE LOW
X

 to change,   to choose,  to save

Definition: This parameter selects the low range to be used for PRIMARY simulated input.

 TO ADVANCE TO NEXT SELECTION



STLR SIP RANGE HIGH
X

 to change,   to choose,  to save

Definition: This parameter selects the high range to be used for PRIMARY simulated input.

 TO ADVANCE TO NEXT SELECTION

STLR SIP PERIOD
X

 to change,   to choose,  to save

Definition: This parameter selects the period to be used for PRIMARY simulated input.

 TO ADVANCE TO NEXT SELECTION







STLR SIS TYPE
[OFF - NO INPUT]
[SINE WAVE]
[SAWTOOTH]
[SQUARE WAVE]
[SPIKES]

 to change,  to choose,  to save

Definition: This parameter selects the type of SECONDARY simulated input.

 TO ADVANCE TO NEXT SELECTION







STLR SIS RANGE LOW
X

  to change,   to choose,   to save

Definition: This parameter selects the low range to be used for SECONDARY simulated input.

  TO ADVANCE TO NEXT SELECTION







STLR SIS RANGE HIGH
X

  to change,   to choose,   to save

Definition: This parameter selects the high range to be used for SECONDARY simulated input.

  TO ADVANCE TO NEXT SELECTION



STLR SIS PERIOD
X

  to change,   to choose,   to save

Definition: This parameter selects the period to be used for SECONDARY simulated input.

  TO ADVANCE TO NEXT SELECTION

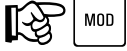



SFLR SIP TYPE
[OFF - NO INPUT]
[SINE WAVE]
[SAWTOOTH]
[SQUARE WAVE]
[SPIKES]

 to change,  to choose,  to save

Definition: This parameter selects the type of SFLR simulated input.

 TO ADVANCE TO NEXT SELECTION

SFLR SIP DECIMAL POS
X

 to change,   to choose,  to save

Definition: This parameter selects number of decimal places to be used for SFLR simulated input.

 TO ADVANCE TO NEXT SELECTION

SFLR SIP DISPLAY TAG
[USER ENTERED TEXT]

 NOTE: Refer to **General Instrument Operation - Modifying Text** for information on this operation.

Definition: This text parameter defines the SFLR tag that is shown on the user display.

 TO ADVANCE TO NEXT SELECTION





SFLR SIP RANGE LOW
X

 to change,   to choose,  to save

Definition: This parameter selects the low range to be used for SFLR simulated input.

 TO ADVANCE TO NEXT SELECTION





SFLR SIP RANGE HIGH
X

 to change,   to choose,  to save

Definition: This parameter selects the high range to be used for SFLR simulated input.

 TO ADVANCE TO NEXT SELECTION

SFLR SIP PERIOD
X

 to change,   to choose,  to save

Definition: This parameter selects the period to be used for SFLR simulated input.

 TO ADVANCE TO NEXT SELECTION







CPRC SIP TYPE
[OFF - NO INPUT]
[SINE WAVE]
[SAWTOOTH]
[SQUARE WAVE]
[SPIKES]

 to change,  to choose,  to save

Definition: This parameter selects the type of CPRC simulated input.

 TO ADVANCE TO NEXT SELECTION

CPRC SIP DECIMAL POS
X

  to change,   to choose,   to save

Definition: This parameter selects number of decimal places to be used for CPRC simulated input.

  TO ADVANCE TO NEXT SELECTION







CPRC SIP DISPLAY TAG
[USER ENTERED TEXT]

 NOTE: Refer to **General Instrument Operation - Modifying Text** for information on this operation.

Definition: This text parameter defines the CPRC tag that is shown on the user display.

  TO ADVANCE TO NEXT SELECTION







CPRC SIP RANGE LOW
X

  to change,   to choose,   to save

Definition: This parameter selects the low range to be used for CPRC simulated input.

  TO ADVANCE TO NEXT SELECTION

CPRC SIP RANGE HIGH
X

  to change,   to choose,   to save

Definition: This parameter selects the high range to be used for CPRC simulated input.

  TO ADVANCE TO NEXT SELECTION

CPRC SIP PERIOD
X

  to change,   to choose,   to save

Definition: This parameter selects the period to be used for CPRC simulated input.

  TO ADVANCE TO NEXT SELECTION







HWC SIP TYPE
[OFF - NO INPUT]
[SINE WAVE]
[SAWTOOTH]
[SQUARE WAVE]
[SPIKES]

  to change,   to choose,   to save

Definition: This parameter selects the type of HWC simulated input.

  TO ADVANCE TO NEXT SELECTION

HWC SIP DECIMAL POS
X

  to change,   to choose,   to save

Definition: This parameter selects number of decimal places to be used for HWC simulated input.

  TO ADVANCE TO NEXT SELECTION







HWC SIP DISPLAY TAG
[USER ENTERED TEXT]

 NOTE: Refer to **General Instrument Operation - Modifying Text** for information on this operation.

Definition: This text parameter defines the HWC tag that is shown on the user display.

  TO ADVANCE TO NEXT SELECTION





HWC SIP RANGE LOW
X

  to change,   to choose,   to save

Definition: This parameter selects the low range to be used for HWC simulated input.

  TO ADVANCE TO NEXT SELECTION





HWC SIP RANGE HIGH
X

 MOD to change,   to choose,  ENTER to save

Definition: This parameter selects the high range to be used for HWC simulated input.

  TO ADVANCE TO NEXT SELECTION

HWC SIP PERIOD X

 MOD to change,   to choose,  ENTER to save

Definition: This parameter selects the period to be used for HWC simulated input.

  TO ADVANCE TO NEXT SELECTION

7.4. Configuration Menu - Current Outputs

This section outlines configuration of the mA current output hardware.

7.4.1. Current Outputs - Shunt Position - RUN MODE

No programming access is allowed under the RUN mode.

7.4.2. Current Outputs - Shunt Position - PROGRAM MODE

While in the PROGRAM MODE, changes may be made to parameters which affect the current outputs. All parameters may not be accessible, as many are dependent on activation by another parameter. The available current outputs are:

STLR INPUT	=	mA retransmission of STLR Input Temperature
SFLR INPUT	=	mA retransmission of SFLR Input Signal
SFLR OUTPUT	=	mA output from SFLR PID Controller
CPRC INPUT	=	mA retransmission of CPRC Input Signal
CPRC OUTPUT	=	mA output from CPRC PID Controller
HWC INPUT	=	mA retransmission of HWC Input Signal
HWC OUTPUT	=	mA output from HWC PID Controller



 NOTE: The AV-9900 is capable of having a maximum of FOUR current outputs.

Access is gained as follows:

 Note: Refer to General Instrument Operations section for instructions on identifying RUN and PROGRAM mode of operation.

From the Normal Display,  key until the following is visible:



SELECT <->
CONFIGURATION

With CONFIGURATION shown in the lower display line,  key.  until the following is visible on the user display:

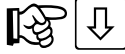
CONFIGURE <->
CURRENT OUTPUTS

With CURRENT OUTPUTS shown in the lower display line,  key.

 to choose desired CURRENT OUTPUT,  to begin programming.

Once all parameters for a specific simulated variable have been programmed, the unit will automatically scroll to the next available function.  will return to the normal display, or  will continue to advance through the next parameter set. Available parameters are:

STLR INP CO TYPE
[0-20 mA]
[4-20 mA]

 to change,  to choose,  to save

Definition: This parameter selects the type of STLR Input Signal Retransmission.

 TO ADVANCE TO NEXT SELECTION





STLR INP DECIMAL POS
X

 to change,   to choose,  to save

Definition: This parameter selects the decimal place to be used if output signal displayed or recorded.

  TO ADVANCE TO NEXT SELECTION





STLR INP RANGE LOW
X

 MOD to change,   to choose,  ENTER to save

Definition: This parameter selects the range low to be used by output signal. Typically matches low end of STLR chart range.

  TO ADVANCE TO NEXT SELECTION



STLR INP RANGE HIGH
X

 MOD to change,   to choose,  ENTER to save

Definition: This parameter selects the range high to be used by output signal. Typically matches high end of STLR chart range.

  TO ADVANCE TO NEXT SELECTION



STLR INP ERROR VALUE
X

 MOD to change,   to choose,  ENTER to save

Definition: This parameter selects the resulting output signal upon an error condition.

  TO ADVANCE TO NEXT SELECTION





SFLR INP CO TYPE
[0-20 mA]
[4-20 mA]

 MOD to change,  to choose,  ENTER to save

Definition: This parameter selects the type of SFLR Input Signal Retransmission.

 TO ADVANCE TO NEXT SELECTION





SFLR INP DECIMAL POS
X

 MOD to change,   to choose,  ENTER to save

Definition: This parameter selects the decimal place to be used if output signal displayed or recorded.

 TO ADVANCE TO NEXT SELECTION

SFLR INP RANGE LOW
X

 MOD to change,   to choose,  ENTER to save

Definition: This parameter selects the range low to be used by output signal. Typically matches low end of SFLR chart range.

 TO ADVANCE TO NEXT SELECTION





SFLR INP RANGE HIGH
X

 MOD to change,   to choose,  ENTER to save

Definition: This parameter selects the range high to be used by output signal. Typically matches high end of SFLR chart range.

  TO ADVANCE TO NEXT SELECTION

SFLR INP ERROR VALUE
X

 MOD to change,   to choose,  ENTER to save

Definition: This parameter selects the resulting output signal upon an error condition.

  TO ADVANCE TO NEXT SELECTION





SFLR OUT CO TYPE
[0-20 mA]
[4-20 mA]

 MOD to change,   to choose,  ENTER to save

Definition: This parameter selects the type of SFLR Output Signal Retransmission.

  TO ADVANCE TO NEXT SELECTION





SFLR OUT DECIMAL POS
X

 MOD to change,   to choose,  ENTER to save

Definition: This parameter selects the decimal place to be used if output signal displayed or recorded.

 TO ADVANCE TO NEXT SELECTION





SFLR OUT RANGE LOW
X

 MOD to change,   to choose,  ENTER to save

Definition: This parameter selects the range low to be used by output signal. Typically matches low end of SFLR chart range.

 TO ADVANCE TO NEXT SELECTION





SFLR INP RANGE HIGH
X

 MOD to change,   to choose,  ENTER to save

Definition: This parameter selects the range high to be used by output signal. Typically matches high end of SFLR chart range.

 TO ADVANCE TO NEXT SELECTION

SFLR INP ERROR VALUE
X

 MOD to change,   to choose,  ENTER to save

Definition: This parameter selects the resulting output signal upon an error condition.

 TO ADVANCE TO NEXT SELECTION



CPRC INP CO TYPE
[0-20 mA]
[4-20 mA]

 to change,  to choose,  to save

Definition: This parameter selects the type of CPRC Input Signal Retransmission.

 TO ADVANCE TO NEXT SELECTION





CPRC INP DECIMAL POS
X

 to change,   to choose,  to save

Definition: This parameter selects the decimal place to be used if output signal displayed or recorded.

 TO ADVANCE TO NEXT SELECTION





CPRC INP RANGE LOW
X

 to change,   to choose,  to save

Definition: This parameter selects the range low to be used by output signal. Typically matches low end of CPRC chart range.

 TO ADVANCE TO NEXT SELECTION





CPRC INP RANGE HIGH
X

 MOD to change,   to choose,  ENTER to save

Definition: This parameter selects the range high to be used by output signal. Typically matches high end of CPRC chart range.

  TO ADVANCE TO NEXT SELECTION

CPRC INP ERROR VALUE
X

 MOD to change,   to choose,  ENTER to save

Definition: This parameter selects the resulting output signal upon an error condition.

  TO ADVANCE TO NEXT SELECTION







CPRC OUT CO TYPE
[0-20 mA]
[4-20 mA]

 MOD to change,   to choose,  ENTER to save

Definition: This parameter selects the type of CPRC Output Signal Retransmission.

  TO ADVANCE TO NEXT SELECTION





CPRC OUT DECIMAL POS
X

  to change,   to choose,   to save

Definition: This parameter selects the decimal place to be used if output signal displayed or recorded.

  TO ADVANCE TO NEXT SELECTION





CPRC OUT RANGE LOW
X

  to change,   to choose,   to save

Definition: This parameter selects the range low to be used by output signal. Typically matches low end of CPRC chart range.

  TO ADVANCE TO NEXT SELECTION







CPRC INP RANGE HIGH
X

  to change,   to choose,   to save

Definition: This parameter selects the range high to be used by output signal. Typically matches high end of CPRC chart range.

  TO ADVANCE TO NEXT SELECTION

CPRC INP ERROR VALUE
X

  to change,   to choose,   to save

Definition: This parameter selects the resulting output signal upon an error condition.

  TO ADVANCE TO NEXT SELECTION







HWC INP CO TYPE
[0-20 mA]
[4-20 mA]

  to change,   to choose,   to save

Definition: This parameter selects the type of HWC Input Signal Retransmission.

  TO ADVANCE TO NEXT SELECTION

HWC INP DECIMAL POS
X





  to change,   to choose,   to save

Definition: This parameter selects the decimal place to be used if output signal displayed or recorded.

  TO ADVANCE TO NEXT SELECTION

HWC INP RANGE LOW





X

 MOD to change,   to choose,  ENTER to save

Definition: This parameter selects the range low to be used by output signal. Typically matches low end of HWC chart range.

  TO ADVANCE TO NEXT SELECTION





HWC INP RANGE HIGH
X

 MOD to change,   to choose,  ENTER to save

Definition: This parameter selects the range high to be used by output signal. Typically matches high end of HWC chart range.

  TO ADVANCE TO NEXT SELECTION

HWC INP ERROR VALUE
X

 MOD to change,   to choose,  ENTER to save

Definition: This parameter selects the resulting output signal upon an error condition.

  TO ADVANCE TO NEXT SELECTION

HWC OUT CO TYPE
[0-20 mA]







[4-20 mA]

  to change,   to choose,   to save

Definition: This parameter selects the type of HWC Output Signal Retransmission.

  TO ADVANCE TO NEXT SELECTION







HWC OUT DECIMAL POS
X

  to change,   to choose,   to save

Definition: This parameter selects the decimal place to be used if output signal displayed or recorded.

  TO ADVANCE TO NEXT SELECTION





HWC OUT RANGE LOW
X

  to change,   to choose,   to save

Definition: This parameter selects the range low to be used by output signal. Typically matches low end of HWC chart range.

  TO ADVANCE TO NEXT SELECTION





HWC INP RANGE HIGH
X

 MOD to change,   to choose,  ENTER to save

Definition: This parameter selects the range high to be used by output signal. Typically matches high end of HWC chart range.

  TO ADVANCE TO NEXT SELECTION

HWC INP ERROR VALUE X

 MOD to change,   to choose,  ENTER to save

Definition: This parameter selects the resulting output signal upon an error condition.

  TO ADVANCE TO NEXT SELECTION

7.5. Configuration Menu - Recording Pens

This section outlines configuration of the recording pens for the following:

- STLR Input and Event
- STLR Setpoint
- SFLR Input and Event
- CPRC Input



Note: For troubleshooting purposes it is possible to activate the following:

- STLR Output recording
- SFLR Output recording
- CPRC Output recording
- HWC Input recording
- HWC Output recording

Depending on instrument configuration, it may be necessary to disable one of the standard pens prior to activating one of the optional pens. Only one function may be performed per color. If all pens are in use, an existing recording pen must be toggled for the temporary pen.

7.5.1. Recording Pens - Shunt Position - RUN MODE

No programming access is allowed under the RUN mode.

7.5.2. Recording Pens - Shunt Position - PROGRAM MODE





Access is gained as follows:





Note: Refer to General Instrument Operations section for instructions on identifying RUN and PROGRAM mode of operation.

From the Normal Display,   key until the following is visible:





SELECT <->
CONFIGURATION

With CONFIGURATION shown in the lower display line,   key.   until the following is visible on the user display:

CONFIGURE <->
RECORDING PENS

With RECORDING PENS shown in the lower display line,   key.

  to choose desired RECORDING PEN,   to begin programming.

Once all parameters for a specific simulated variable have been programmed, the unit will automatically scroll to the next available function.   will return to the normal display, or   will continue to advance through the next parameter set. Available parameters are:



STLR INP PEN TAG
[USER ENTERED TEXT]

 NOTE: Refer to **General Instrument Operation - Modifying Text** for information on this operation.

Definition: This text parameter defines the STLR tag that is printed on the chart scale.

  TO ADVANCE TO NEXT SELECTION





STLR INP DECIMAL POS
X

  to change,   to choose,   to save

Definition: This parameter selects the decimal places for the STLR chart scale.

 TO ADVANCE TO NEXT SELECTION





STLR INP ZONE LOW
DIVISION X

 to change,   to choose,  to save

Definition: This parameter determines the start of chart scale. MUST REMAIN AT “0”.

 TO ADVANCE TO NEXT SELECTION





STLR INP ZONE HIGH
DIVISION X

 to change,   to choose,  to save

Definition: This parameter determines the end of chart scale. MUST REMAIN AT “100”.

 TO ADVANCE TO NEXT SELECTION

STLR INP ZONE LOW
VALUE X





 to change,   to choose,  to save

Definition: This parameter determines the start of chart scale value. Follows Pasteurized Milk Ordinance guidelines for recording charts.

 TO ADVANCE TO NEXT SELECTION

STLR INP ZONE HIGH





VALUE X

 MOD to change,   to choose,  ENTER to save

Definition: This parameter determines the end of chart scale value. Follows Pasteurized Milk Ordinance guidelines for recording charts.

  TO ADVANCE TO NEXT SELECTION

STLR INP INTERVAL
X DIVISIONS





 MOD to change,   to choose,  ENTER to save

Definition: This parameter determines the frequency at which the scale information will be printed to the chart.

Example: Range 120-220
Divisions set to 20
Chart scale = 120 140 160 etc.

  TO ADVANCE TO NEXT SELECTION

STLR INP ERROR POSN
DIVISIONS X

 MOD to change,   to choose,  ENTER to save

Definition: This parameter determines where the pen will be positioned on an error condition.

  TO ADVANCE TO NEXT SELECTION

This completes STLR Input/Event pen setup.   to return to normal display, or   to continue with next parameter set.





STLR SP PEN TAG [USER ENTERED TEXT]
--

 NOTE: Refer to **General Instrument Operation - Modifying Text** for information on this operation.

Definition: This text parameter defines the STLR SP tag that is printed on the chart scale.

  TO ADVANCE TO NEXT SELECTION





STLR SP DECIMAL POS X

  to change,   to choose,   to save

Definition: This parameter selects the decimal places for the STLR SP chart scale.

  TO ADVANCE TO NEXT SELECTION



STLR SP ZONE LOW DIVISION X

  to change,   to choose,   to save

Definition: This parameter determines the start of chart scale. MUST REMAIN AT “0”.

  TO ADVANCE TO NEXT SELECTION

STLR SP ZONE HIGH
DIVISION X

 MOD to change,   to choose,  ENTER to save

Definition: This parameter determines the end of chart scale. MUST REMAIN AT “100”.

  TO ADVANCE TO NEXT SELECTION





STLR SP ZONE LOW
VALUE X

 MOD to change,   to choose,  ENTER to save

Definition: This parameter determines the start of chart scale value. This value automatically tracks the STLR Input/Event scale.

  TO ADVANCE TO NEXT SELECTION





STLR SP ZONE HIGH
VALUE X

 MOD to change,   to choose,  ENTER to save

Definition: This parameter determines the end of chart scale value. This value automatically tracks the STLR Input/Event scale.

  TO ADVANCE TO NEXT SELECTION

STLR SP INTERVAL
X DIVISIONS



 MOD to change,   to choose,  ENTER to save

Definition: This parameter determines the frequency at which the scale information will be printed to the chart.

Example: Range 120-220
 Divisions set to 20
 Chart scale = 120 140 160 etc.



  TO ADVANCE TO NEXT SELECTION

STLR SP ERROR POSN
DIVISIONS X

 MOD to change,   to choose,  ENTER to save

Definition: This parameter determines where the pen will be positioned on an error condition.

  TO ADVANCE TO NEXT SELECTION

This completes STLR Setpoint pen setup.  RESET to return to normal display, or   to continue with next parameter set.

SFLR INP PEN TAG
[USER ENTERED TEXT]

 NOTE: Refer to **General Instrument Operation - Modifying Text** for information on this operation.

Definition: This text parameter defines the SFLR INP tag that is printed on the chart scale.

 TO ADVANCE TO NEXT SELECTION



SFLR INP DECIMAL POS
X

 to change,   to choose,  to save

Definition: This parameter selects the decimal places for the SFLR INP chart scale.

 TO ADVANCE TO NEXT SELECTION

SFLR INP ZONE LOW
DIVISION X

 to change,   to choose,  to save

Definition: This parameter determines the start of chart scale. MUST REMAIN AT “0”.

 TO ADVANCE TO NEXT SELECTION





SFLR INP ZONE HIGH
DIVISION X

 to change,   to choose,  to save

Definition: This parameter determines the end of chart scale. MUST REMAIN AT “40”. DO NOT MODIFY PER FOOD & DRUG ADMINISTRATION REGULATIONS

 TO ADVANCE TO NEXT SELECTION

SFLR INP ZONE LOW
VALUE X

 to change,   to choose,  to save

Definition: This parameter determines the start of chart scale value.
Typically set to a value of 0.

 TO ADVANCE TO NEXT SELECTION

SFLR INP ZONE HIGH
VALUE X

 to change,   to choose,  to save

Definition: This parameter determines the end of chart scale value.
Programmed per customer order in units matching either
% Flow, or actual unit value received at 20 mA output
state of flow meter.

 TO ADVANCE TO NEXT SELECTION

SFLR INP INTERVAL
X DIVISIONS

 to change,   to choose,  to save

Definition: This parameter determines the frequency at which the scale
information will be printed to the chart.

Example: Range 0-40
Divisions set to 20
Chart scale equally printed at
division 0, 20 and 40



 TO ADVANCE TO NEXT SELECTION

SFLR INP ERROR POSN
DIVISIONS X

 MOD to change,   to choose,  ENTER to save

Definition: This parameter determines where the pen will be positioned on an error condition.

 TO ADVANCE TO NEXT SELECTION

This completes SFLR INP pen setup.  RESET to return to normal display, or  to continue with next parameter set.





CPRC INP PEN TAG
[USER ENTERED TEXT]

 NOTE: Refer to **General Instrument Operation - Modifying Text** for information on this operation.

Definition: This text parameter defines the CPRC tag that is printed on the chart scale.

 TO ADVANCE TO NEXT SELECTION





CPRC INP DECIMAL POS
X

 to change,   to choose,  to save

Definition: This parameter selects the decimal places for the CPRC INP chart scale.

 TO ADVANCE TO NEXT SELECTION

CPRC INP ZONE LOW
DIVISION X

 to change,   to choose,  to save

Definition: This parameter determines the start of chart scale. MUST REMAIN AT “0”.

 TO ADVANCE TO NEXT SELECTION





CPRC INP ZONE HIGH
DIVISION X

 to change,   to choose,  to save

Definition: This parameter determines the end of chart scale. MUST REMAIN AT “100”.

 TO ADVANCE TO NEXT SELECTION





CPRC INP ZONE LOW
VALUE X

 to change,   to choose,  to save

Definition: This parameter determines the start of chart scale value.

 TO ADVANCE TO NEXT SELECTION





CPRC INP ZONE HIGH
VALUE X

 to change,   to choose,  to save

Definition: This parameter determines the end of chart scale value.

 TO ADVANCE TO NEXT SELECTION

CPRC INP INTERVAL
X DIVISIONS

 to change,   to choose,  to save





Definition: This parameter determines the frequency at which the scale information will be printed to the chart.

Example: Range 120-220
Divisions set to 20

Chart scale = 120 140 160 etc.

 TO ADVANCE TO NEXT SELECTION

CPRC INP ERROR POSN
DIVISIONS X

 to change,   to choose,  to save

Definition: This parameter determines where the pen will be positioned on an error condition.

 TO ADVANCE TO NEXT SELECTION

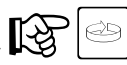
This completes CPRC INP pen setup.  to return to normal display, or  to continue with next parameter set.

7.6. Configuration Menu - Chart Messages

7.6.1. Chart Messages - Shunt Position - RUN MODE

No programming access is allowed under the RUN mode.

7.6.2. Chart Messages - Shunt Position - PROGRAM MODE

Consult factory for additional information.

7.7. Configuration Menu - Operator Messages

7.7.1. Operator Messages - Shunt Position - RUN MODE

No programming access is allowed under the RUN mode.

7.7.2. Operator Messages - Shunt Position - PROGRAM MODE

Consult factory for additional information.

7.8. Configuration Menu - Operator Inputs

7.8.1. Operator Inputs - Shunt Position - RUN MODE

No programming access is allowed under the RUN mode.

7.8.2. Operator Inputs - Shunt Position - PROGRAM MODE

Consult factory for additional information.

7.9. Configuration Menu - Derived Actuators

7.9.1. Derived Actuators - Shunt Position - RUN MODE

No programming access is allowed under the RUN mode.

7.9.2. Derived Actuators - Shunt Position - PROGRAM MODE



STOP: DO NOT ALTER SETTINGS FOR DERIVED ACTUATORS.

7.10. Configuration Menu - LED's

7.10.1. LED's - Shunt Position - RUN MODE

No programming access is allowed under the RUN mode.





7.10.2. LED's - Shunt Position - PROGRAM MODE





Note: Refer to General Instrument Operations section for instructions on identifying RUN and PROGRAM mode of operation.

From the Normal Display,   key until the following is visible:

```
SELECT    <->
CONFIGURATION
```

With CONFIGURATION shown in the lower display line,   key.   until the following is visible on the user display:





```
CONFIGURE    <->
LEDS
```

With LEDS shown in the lower display line,   key.

Available parameters are:

LED X ACTUATOR	
[NONE/OFF]	
[ON/CONTINUOUS]	
[ANY LARM]	
[INSTRUMENT ALARM]	
[CHART FULL ALARM]	
[SFLR ALARM 1]	
[SFLR ALARM 2]	
[CPR ALARM 1]	
[CPR ALARM 2]	
[HWC ALARM 1]	
[HWC ALARM 2]	
[CHART RUN STATE]	
[DATA COLLECT STATE]	
[CONTROL ON STATE]	
[FWD FLOW ENABLED]	
[FWD FLOW REQUESTED]	
[STLR INPUT MISMATCH]	
[STLR OUT	STLR ERR]
[SFLR OUT	SFLR ERR]
[CPRC OUT	CPRC ERR]
[HWC OUT	HWC ERR]
[OP INP 1	OP INP 2]
[OP INP 3	OP INP 4]
[OP INP 5	OP INP 6]
[OP INP 7	OP INP 8]

[DA1 DA2 DA3 DA4]
[DA5 DA6 DA7 DA8]
[F1 F2 F3 F4 F5]
[RESET MOD ENTER]

  to change,   to choose,   to save

Definition: This parameter allows linking an LED to a system event.

  to select next LED, or   to return to normal display.

7.11. Configuration Menu - Relays

7.11.1. Relays - Shunt Position - RUN MODE





No programming access is allowed under the RUN mode.

7.11.2. Relays - Shunt Position - PROGRAM MODE



 Note: Refer to General Instrument Operations section for instructions on identifying RUN and PROGRAM mode of operation.

From the Normal Display,   key until the following is visible:

```
SELECT          <->
CONFIGURATION
```

With CONFIGURATION shown in the lower display line,   key.   until the following is visible on the user display:







```
CONFIGURE      <->
RELAYS
```

With RELAYS shown in the lower display line,   key.

Available parameters are:

RELAY X ACTUATOR
[NONE/OFF]
[ON/CONTINUOUS]
[ANY LARM]
[INSTRUMENT ALARM]
[CHART FULL ALARM]
[SFLR ALARM 1]
[SFLR ALARM 2]
[CPR ALARM 1]
[CPR ALARM 2]
[HWC ALARM 1]
[HWC ALARM 2]
[CHART RUN STATE]
[DATA COLLECT STATE]
[CONTROL ON STATE]
[FWD FLOW ENABLED]
[FWD FLOW REQUESTED]
[STLR INPUT MISMATCH]
[STLR OUT STLR ERR]
[SFLR OUT SFLR ERR]
[CPRC OUT CPRC ERR]
[HWC OUT HWC ERR]
[OP INP 1 OP INP 2]
[OP INP 3 OP INP 4]
[OP INP 5 OP INP 6]
[OP INP 7 OP INP 8]
[DA1 DA2 DA3 DA4]
[DA5 DA6 DA7 DA8]
[F1 F2 F3 F4 F5]





[RESET MOD ENTER]

  to change,   to choose,   to save

Definition: This parameter allows linking a Relay to a system event.

NOTE: For Flow applications, Relay 1 programmed to SFLR Alarm 1, Relay 2 programmed to SFLR Alarm 2. **DO NOT MODIFY** this setting.

Wiring for Legal Flow (Meter Based Timing) system is connected to normally open contacts of both relays. This will provide fail-safe operation of the legal flow circuit.

  to select next RELAY, or   to return to normal display.

8. Program Reference - Tests Menu

 **CAUTION:** As certain tests may take control of the AV-9900, switching outputs, be sure that a safe condition exists before proceeding. DO NOT attempt while processing.

8.1. Tests Menu

8.1.1. Tests - Shunt Position - RUN MODE

No tests are available while unit is in the RUN mode.

8.1.2. Tests - Shunt Position - PROGRAM MODE



While in the RUN MODE, Instrument Tests may be performed for calibration or troubleshooting purposes. Access is gained as follows:

 **Note:** Refer to General Instrument Operations section for instructions on identifying RUN and PROGRAM mode of operation.

From the Normal Display,   key until the following is visible:

```
SELECT  <->
TESTS
```

With TESTS shown in the lower display line,   key.   To select the desired test.

With desired test shown in the lower display line,   key and follow system prompts. Available tests are as follows:

RELAYS	Used to verify that all mechanical relays (Optional), as well as the mainHTST logic relay are working.
DISPLAY	Used to verify operation of user display.
KEYPAD	Used to verify operation of keypad.
LEDS	Used to verify operation of LED's
A/D ADC FAIL COUNT	FACTORY USE ONLY
A/D RAW HEX COUNTS	FACTORY USE ONLY

CAL'ED INPUT VALUES

FACTORY USE ONLY

mA OUTPUTS

Verify mA output is functional

Follow individual system prompts to initiate and complete desired test.

9. Program Reference - Calibration Menu

 **CAUTION:** As certain tests may take control of the AV-9900, switching outputs, be sure that a safe condition exists before proceeding. DO NOT attempt while processing.

9.1. Calibration Menu

9.1.1. Calibration - Shunt Position - RUN MODE

No calibration adjustments are available while unit is in the RUN mode.





9.1.2. Calibration - Shunt Position - PROGRAM MODE



While in the RUN MODE, Instrument Calibration may be performed for calibration or troubleshooting purposes. Access is gained as follows:



 **Note:** Refer to General Instrument Operations section for instructions on identifying RUN and PROGRAM mode of operation.

From the Normal Display,   key until the following is visible:

SELECT <->
CALIBRATION

With CALIBRATION shown in the lower display line,   key.   To select the desired procedure.

With desired procedure shown in the lower display line,   key and follow system prompts. Available calibrations are as follows:

mA OUTPUTS	Allows calibration of current outputs.
SOLENOID ADJUSTMENT	FACTORY PROCEDURE
CHART CALIBRATION	Allows calibration of pen zero and span.
PARAMETER DEFAULTS	 Initiates DEFAULT values. ERASES ALL FACTORY PROGRAMMING
INPUT CALIBRATION	 CONSULT FACTORY BEFORE PROCEEDING



10. Program Reference - Model & Revision Menu





10.1. Model & Revision Menu

10.1.1. Model & Revision - Shunt Position - RUN MODE / PROGRAM MODE

From the Normal Display,   key until the following is visible:

```
SELECT <->
MODEL AND REVISION
```

With MODEL AND REVISION shown in the lower display line,   key.

  to view Model and Software Revision,   to return to normal display.

11. Chart - Operation and Configuration

While in the PROGRAM MODE, changes may be made to Chart related parameters. Access is gained as follows:

From the Normal Display,   key until the following is visible:

MODIFY <->
CHART CONFIGURATION



  key. The following parameters will now be visible on the user display:

CHART TAG
USER ENTERED TEXT

for

 NOTE: Refer to General Instrument Operation - Modifying Text information on this operation.

Definition: This parameter is used as an identification tag. It appears on the outside edge of the chart.

  TO ADVANCE TO NEXT SELECTION

CHART SPEED
[6 HOURS]
[8 HOURS]
[12 HOURS]
[24 HOURS]

chart
Operations
alternate rotation
agent prior to

 NOTE: The U.S. Pasteurized Milk Ordinance requires a 12 hour rotation for all milk pasteurization operations. such as juice pasteurization may allow speeds. Be sure to verify with your local making changes to rotation time.

  to change,  or  to choose,   to save

Definition: This parameter allows selection of the chart rotation time.

  TO ADVANCE TO NEXT SELECTION

MAJOR TIME PERIODS
XX

Pasteurized
parameter MUST
Period will be printed at

 NOTE: If unit has been programmed at the Factory for a Milk Ordinance regulated product, this remain at 12. One Major Time each hour.

 MOD to change,   to choose,  ENTER to save



Definition: This parameter allows selection of the chart Major Time Periods. A Major Time Period is a dark line, with pen scales, printed to the chart that divides the chart to sections. (Ex. 12 majors on a 12 hour rotation = 1 major per hour)

  TO ADVANCE TO NEXT SELECTION

MINOR TIME PERIODS
XX

Pasteurized
parameter MUST
Lines (Four Minor
printed per hour.

 NOTE: If unit has been programmed at the Factory for a Milk Ordinance regulated product, this remain at 4. Three Minor Time Time Periods) will be

 MOD to change,   to choose,  ENTER to save

Definition: This parameter allows selection of the chart Minor Time Periods. A Minor Time Period is a dotted line printed to the chart that divides the chart, between Major Periods, into further sections. (Ex. 12 majors on a 12 hour rotation with 4 minors = 1 major per hour, with 4 minor periods between each major)

  TO ADVANCE TO NEXT SELECTION

BLANK MAJOR PERIODS
XX

Pasteurized
parameter MUST

 NOTE: If unit has been programmed at the Factory for a Milk Ordinance regulated product, this remain at 0.

 MOD to change,   to choose,  ENTER to save

Definition: This parameter allows selection of the chart Blank Major Time Periods. A Blank Major is similar to a Major Time Period line, with the exception that NO scale information is printed to the chart.

  TO ADVANCE TO NEXT SELECTION

MAJOR LINE PEN / COLOR
[MATCH SCALE COLOR]
[SELECT A COLOR]

 MOD to change,  or  to choose,  ENTER to save

Definition: This parameter allows selection of the color for the Major Time line printed to the chart. Each pen has a color associated with it. Match scale color will use this color. Select a color will allow the user to define the color of choice in the next menu option.

  TO ADVANCE TO NEXT SELECTION

MAJOR LINE PEN / COLOR
[BLUE]
[GREEN]
[RED]
[BLACK]



NOTE: If previous parameter set to Match Scale Color, this menu option not active.



to change,



or



to choose,



to save

Definition: This parameter allows selection of the color for the Major Time line printed to the chart.



TO ADVANCE TO NEXT SELECTION

MINOR LINE PEN / COLOR
[MATCH SCALE COLOR]
[SELECT A COLOR]



to change,



or



to choose,



to save





Definition: This parameter allows selection of the color for the Minor Time line printed to the chart. Each pen has a color associated with it. Match scale color will use this color. Select a color will allow the user to define the color of choice in the next menu option.



TO ADVANCE TO NEXT SELECTION

MINOR LINE PEN / COLOR
[BLUE]
[GREEN]
[RED]
[BLACK]

 NOTE: If previous parameter set to Match Scale Color, this menu option not active.

  to change,  or  to choose,   to save

Definition: This parameter allows selection of the color for the Minor Time line printed to the chart.

  TO ADVANCE TO NEXT SELECTION

TIME PEN / COLOR
[BLUE]
[GREEN]
[RED]
[BLACK]

  to change,  or  to choose,   to save

Definition: This parameter allows selection of the color for the Time printed to the chart.

  TO ADVANCE TO NEXT SELECTION

DATE PEN / COLOR
[BLUE]
[GREEN]
[RED]
[BLACK]

  to change,  or  to choose,   to save

Definition: This parameter allows selection of the color for the Date printed to the chart.

  TO ADVANCE TO NEXT SELECTION

CHART TAG PEN / COLOR
[BLUE]
[GREEN]
[RED]

[BLACK]

  to change,  or  to choose,   to save

Definition: This parameter allows selection of the color for the Chart Tag printed to the chart.

  TO ADVANCE TO NEXT SELECTION



ACTION ON NEW CHART [NONE - JUST CONTINUE] [PRINT RANGE LIST] [PRINT SCALES]

 NOTE: If unit has been programmed at the Factory for a Pasteurized Milk Ordinance regulated product, this parameter MUST remain at NONE - JUST CONTINUE.

  to change,  or  to choose,   to save

Definition: This parameter specifies the action that takes place at the Start New Chart event.

  TO ADVANCE TO NEXT SELECTION

This completes Chart program options -   to return to main display.

12. Appendix I - Warranty Information

Warranty and Return Statement

These products are sold by The Anderson Instrument Company (Anderson) under the warranties set forth in the following paragraphs. Such warranties are extended only with respect to a purchase of these products, as new merchandise, directly from Anderson or from an Anderson distributor, representative or reseller, and are extended only to the first buyer thereof who purchases them other than for the purpose of resale.

Warranty

These products are warranted to be free from functional defects in materials and workmanship at the time the products leave the Anderson factory and to conform at that time to the specifications set forth in the relevant Anderson instruction manual or manuals, sheet or sheets, for such products for a period of two years.

THERE ARE NO EXPRESSED OR IMPLIED WARRANTIES WHICH EXTEND BEYOND THE WARRANTIES HEREIN AND ABOVE SET FORTH. ANDERSON MAKES NO WARRANTY OF MERCHANTABILITY OR FITNESS FOR A PARTICULAR PURPOSE WITH RESPECT TO THE PRODUCTS.

Limitations

Anderson shall not be liable for any incidental damages, consequential damages, special damages, or any other damages, costs or expenses excepting only the cost or expense of repairs or replacement as described above.

Products must be installed and maintained in accordance with Anderson instructions. Users are responsible for the suitability of the products to their application. There is no warranty against damage resulting from corrosion, misapplication, improper specifications or other operating condition beyond our control. Claims against carriers for damage in transit must be filed by the buyer.

This warranty is void if the purchaser uses non-factory approved replacement parts and supplies or if the purchaser attempts to repair the product themselves or through a third party without Anderson authorization.

Returns

Anderson's sole and exclusive obligation and buyer's sole and exclusive remedy under the above warranty is limited to repairing or replacing (at Anderson's option), free of charge, the products which are reported in writing to Anderson at its main office indicated below.

Anderson is to be advised of return requests during normal business hours and such returns are to include a statement of the observed deficiency. The buyer shall pre-pay shipping charges for products returned and Anderson or its representative shall pay for the return of the products to the buyer.

An RMA (Return Merchandise Authorization) must be obtained from Anderson Customer Service before returning merchandise.

Approved returns should be sent to: Anderson Instrument Co., Inc.
156 Auriesville Rd.
Fultonville, NY 12072

ATTN: Repairs
Write RMA number on outside of package also