

C1900

Circular chart recorder and recorder/controller



Pasteurizer versions supplement

Measurement made easy

—
C1900
circular chart recorder
and recorder/controller

For more information

Further publications are available for free download from:

www.abb.com/recorders

or by scanning this code:



Search for or click on

Data Sheet
C1900
Circular chart recorder [DS/C1900R-EN](#)

Data Sheet
C1900
Circular chart recorder/controller [DS/C1900RC-EN](#)

Quick Reference Guide
C1900 recorders [IM/C1900-QR](#)

Quick Reference Guide
C1900 recorder and recorder/controller [IM/C1900-QC](#)

Search for or click on

Installation Guide
C1900
Circular chart recorder and
recorder/controller [IM/C1900-INS](#)

Operating Guide
C1900
Circular chart recorder [IM/C1900-OGR](#)

Operating Guide
C1900
Circular chart recorder/controller [IM/C1900-OGC](#)

Programming Guide
C1900
Circular chart recorder [IM/C1900-PGR](#)

Programming Guide
C1900
Circular chart recorder/controller [IM/C1900-PGC](#)

Operating Instructions
C1900
Circular chart recorder and
recorder/controller [IM/C1900-MOD](#)

Electrical safety

This equipment complies with the requirements of CEI/IEC 61010-1:2001-2 'Safety Requirements for Electrical Equipment for Measurement, Control and Laboratory Use'. If the equipment is used in a manner NOT specified by the Company, the protection provided by the equipment may be impaired.

Symbols

One or more of the following symbols may appear on the equipment labelling:



Warning – refer to the manual for instructions



Caution – risk of electric shock



Protective earth (ground) terminal



Earth (ground) terminal



Direct current supply only



Alternating current supply only



Both direct and alternating current supply



The equipment is protected through double insulation

Information in this manual is intended only to assist our customers in the efficient operation of our equipment. Use of this manual for any other purpose is specifically prohibited and its contents are not to be reproduced in full or part without prior approval of the Technical Publications Department.

Health and safety

To ensure that our products are safe and without risk to health, the following points must be noted:

- The relevant sections of these instructions must be read carefully before proceeding.
- Warning labels on containers and packages must be observed.
- Installation, operation, maintenance and servicing must only be carried out by suitably trained personnel and in accordance with the information given.
- Normal safety precautions must be taken to avoid the possibility of an accident occurring when operating in conditions of high pressure and/or temperature.
- Chemicals must be stored away from heat, protected from temperature extremes and powders kept dry. Normal safe handling procedures must be used.
- When disposing of chemicals ensure that no two chemicals are mixed.

Safety advice concerning the use of the equipment described in this manual or any relevant hazard data sheets (where applicable) may be obtained from the Company address on the back cover, together with servicing and spares information.

CONTENTS

Section	Page
1 INTRODUCTION	1
1.1 Dairy/Pasteurization Models	2
2 DISPLAYS AND CONTROLS	3
2.1 Displays and L.E.D. Indicators	3
2.2 True Time Event Pen	3
2.3 Faceplate Combinations and Product Codes	4
3 PREPARATION	5
3.1 Checking the Instrument Code Number	5
4 ELECTRICAL INSTALLATION	6
4.1 Identifying the Input/Output Modules (and accessing the Configuration Levels)	6
4.2 Standard Connections	6
4.3 Dairy Relay Board Connections	6
5 OPERATION	7
5.1 Operating Sequence	7
6 OPERATING LEVEL	8
6.1 Operating Level	8
6.1.1 Pen Adjustment Frame	9
6.1.2 Instrument Option Frame	9
6.1.3 View Divert Parameters	10
7 BASIC CONFIGURATION LEVEL	11
7.1 Basic Configuration Level	11
7.1.1 Set Up Input	12
7.1.2 Set Up Pen Range	12
7.1.3 Set Up Chart	12
7.1.4 Set Up Alarms	12
7.1.5 Divert Page	12
7.1.6 Set Up Relay Output	15
7.1.7 Digital Inputs	15
7.1.8 Set Up Digital Output	15
7.1.9 Set Up Analogue Output	15
7.1.10 Access Page	15
7.1.11 Scale Adjust	15
8 ADVANCED CONFIGURATION LEVEL	16
8.1 Advanced Configuration Level	16
8.1.1 Set Up Pen Functions	16

1 INTRODUCTION

The C1900 Series of Documentation is shown in Fig. 1.1.

This User Guide details three Dairy/Pasteurization variants within the C1900 range and must be read in conjunction with the other documentation in the C1900 series.

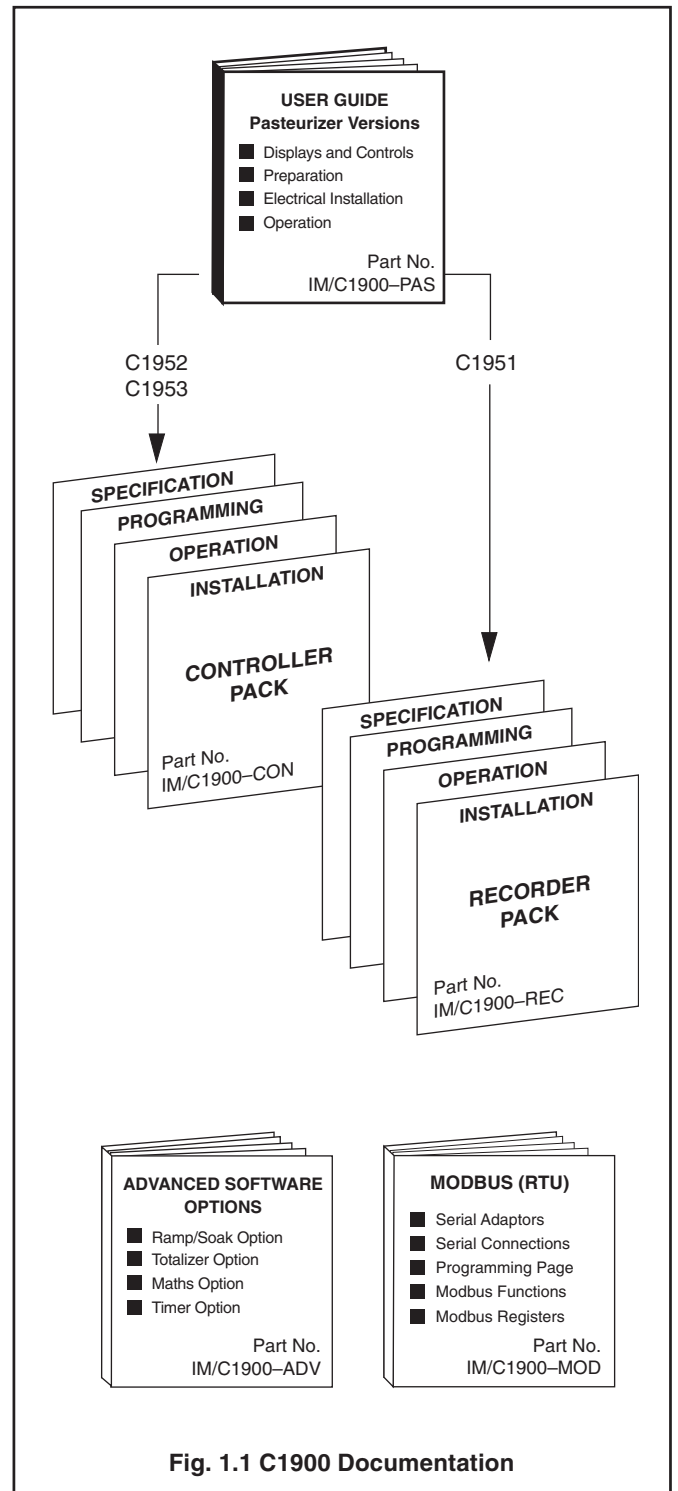

...1 INTRODUCTION

1.1 Dairy/Pasteurization Models

The three models are: 1951 Recorder, 1952 Recorder/Controller and 1953 Recorder/Controller (enhanced). These provide the following features:

- dual RTD measurement of hot product,
- up to 8 diversion set points available,
- LED indication of forward and divert flow conditions,
- leak valve detection safety input,
- continuous hot product and divert set point display,
- forward/divert true-time event pen – can be extended to show cleaning in place (CIP),
- optional fourth analog input to record flow, pressure or other dairy related parameters on blue pen (1953 only).

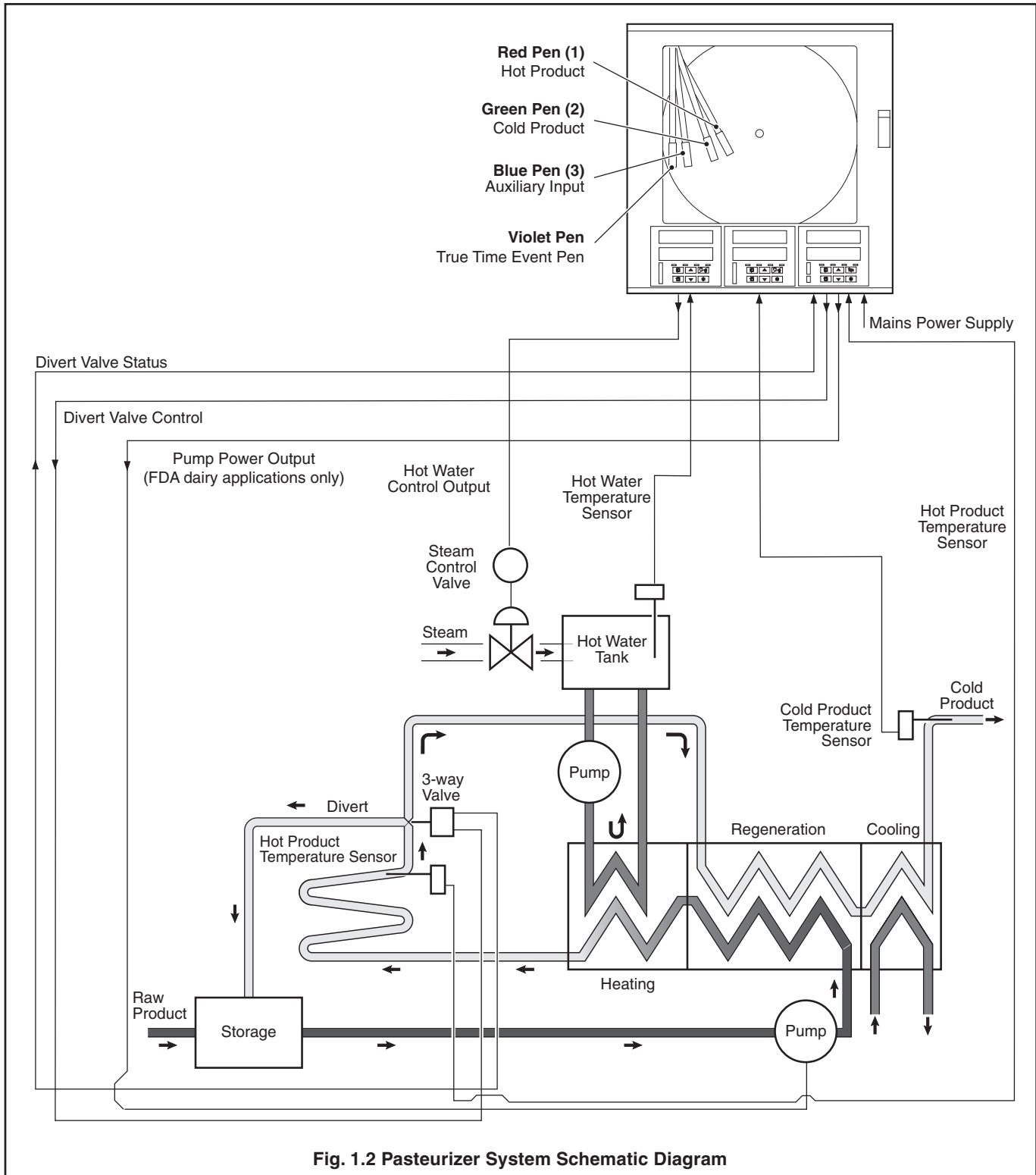

2 DISPLAYS AND CONTROLS

2.1 Displays and L.E.D. Indicators – Fig. 2.1

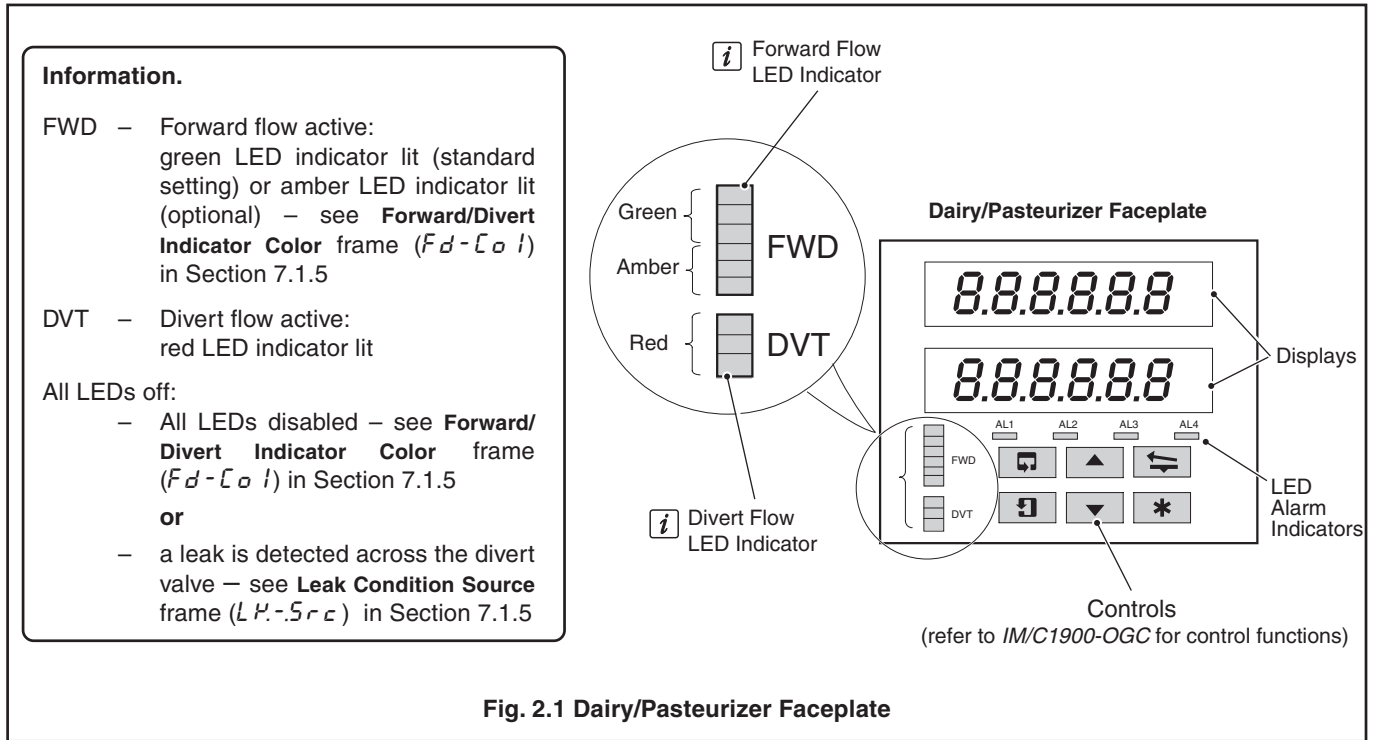

2.2 True Time Event Pen – Fig. 2.2

The True Time Event Pen (violet) indicates the divert status according to the divert valve position. The Event Time Line (red) is coincident with the hot product. Event traces for the different divert states are shown in Fig. 2.2.

Note. All other pens are limited to 94% of the chart to prevent collision with the True Time Event Pen.

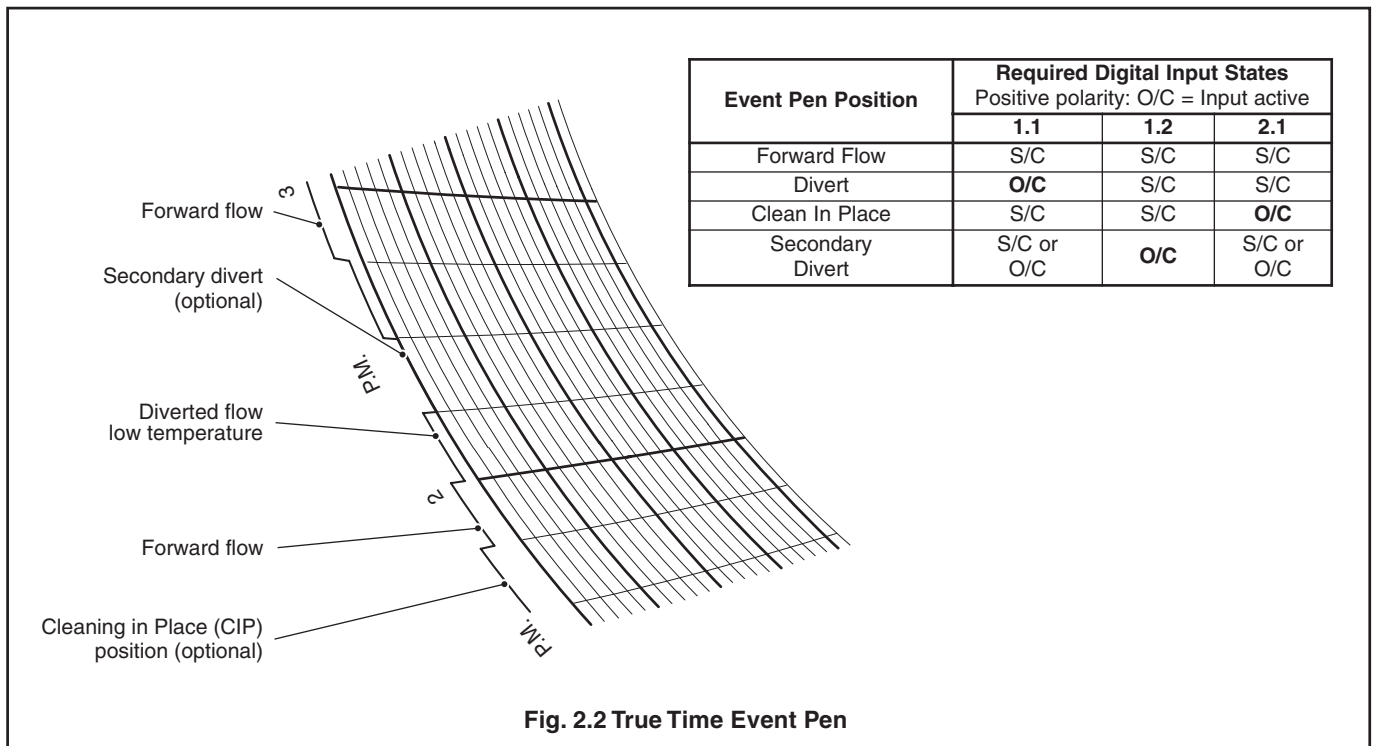

...2 DISPLAYS AND CONTROLS

2.3 Faceplate Combinations and Product Codes – Fig. 2.3

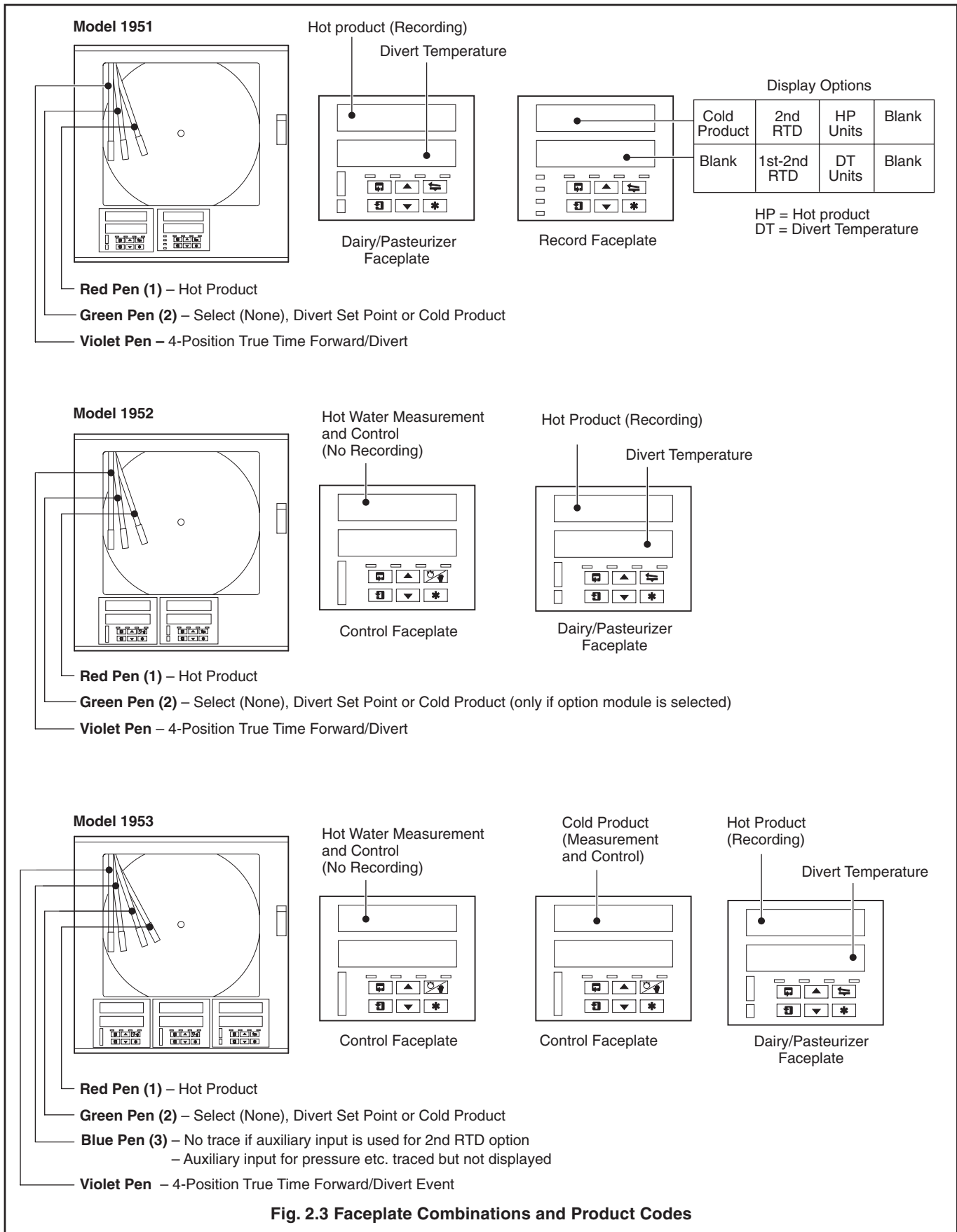

3 PREPARATION

3.1 Checking the Instrument Code Number – Table. 3.1

Part 1 – General Details

1900 Recorder, Recorder/Controller Dairy/Pasteurization Variants		19 XXX	X	X	0	X	X	X	0	X	X	X	XXX
Recorders and Chart Type	Safety Thermal Limit Recorder (STLR), Two pens (Red and Green) plus True Time Event Pen (Violet), Taylor ER/C charts	51J											
	Safety Thermal Limit Recorder (STLR), Two pens (Red and Green) plus True Time Event Pen (Violet), Kent PX105 charts	51K											
Recorder/ Controllers and Chart Type	High Temperature Short Time (HTST) Recording Controllers (HTST) One Control Unit, Two Pens (Red and Green), Plus True Time Event (Violet), Taylor ER/C charts	52R											
	(HTST) One Control Unit, Two Pens (Red and Green), Plus True Time Event (Violet), Kent PX105 charts	52S											
	(HTST) Two Control Units, Three Pens (Red, Green and Blue), Plus True Time Event (Violet), Taylor ER/C charts	53R											
	(HTST) Two Control Units, Three Pens (Red, Green and Blue), Plus True Time Event (Violet), Kent PX105 charts	53S											
Electrical Code	Standard CSA		A	B									
Option Module	None Additional Modules – Part 2 below		0	A									
Options	None				0								
Door Lock	Not Fitted							1					
	Fitted							2					
Power Supply	115V AC											1	
	230V AC											2	
	24V AC											3	

Part 2 – Additional Modules

Module Position 2	1952 Enter code 1 for optional cold product module 1951 and 1953 Enter code 0 cold product module always fitted	0	1										
Module Position 3	1952 and 1953 Enter code 0, hot water module always fitted 1951 No option permitted	0											
Module Position 4	Enter code 1 or 2 for auxiliary input module For other options see key below	0	1	2	3	4	5						
Module Position 5	Enter option 9 for FDA dairy applications (115V only) For other options see key below	0	-	2	3	4	-					9	
Module Position 6	If option 9 is selected is selected above, no other option is permitted	0	-	2	-	4	5					8	
Special Settings	Company Standard Customer Setting Special												STD CUS SXX

Table 3.1 Code Number Interpretation

All units are provided with a True Time Event Pen as standard.

Key to Module Types

- 0 No module fitted
- 1 Standard Input/Output
- 2 Analog Input plus Relay
- 3 Four Relays
- 4 Eight Digital Inputs

- 5 Eight Digital Outputs
- 8 MODBUS RS485 Communications (MODBUS configurator must be set to READ only)
- 9 Dairy Relay Board (takes module positions 5 and 6), 115V only

Refer to Fig. 4.1 for module positions and identification.

4 ELECTRICAL INSTALLATION

4.1 Identifying the Input/Output Modules (and accessing the Configuration Levels) – Fig. 4.1

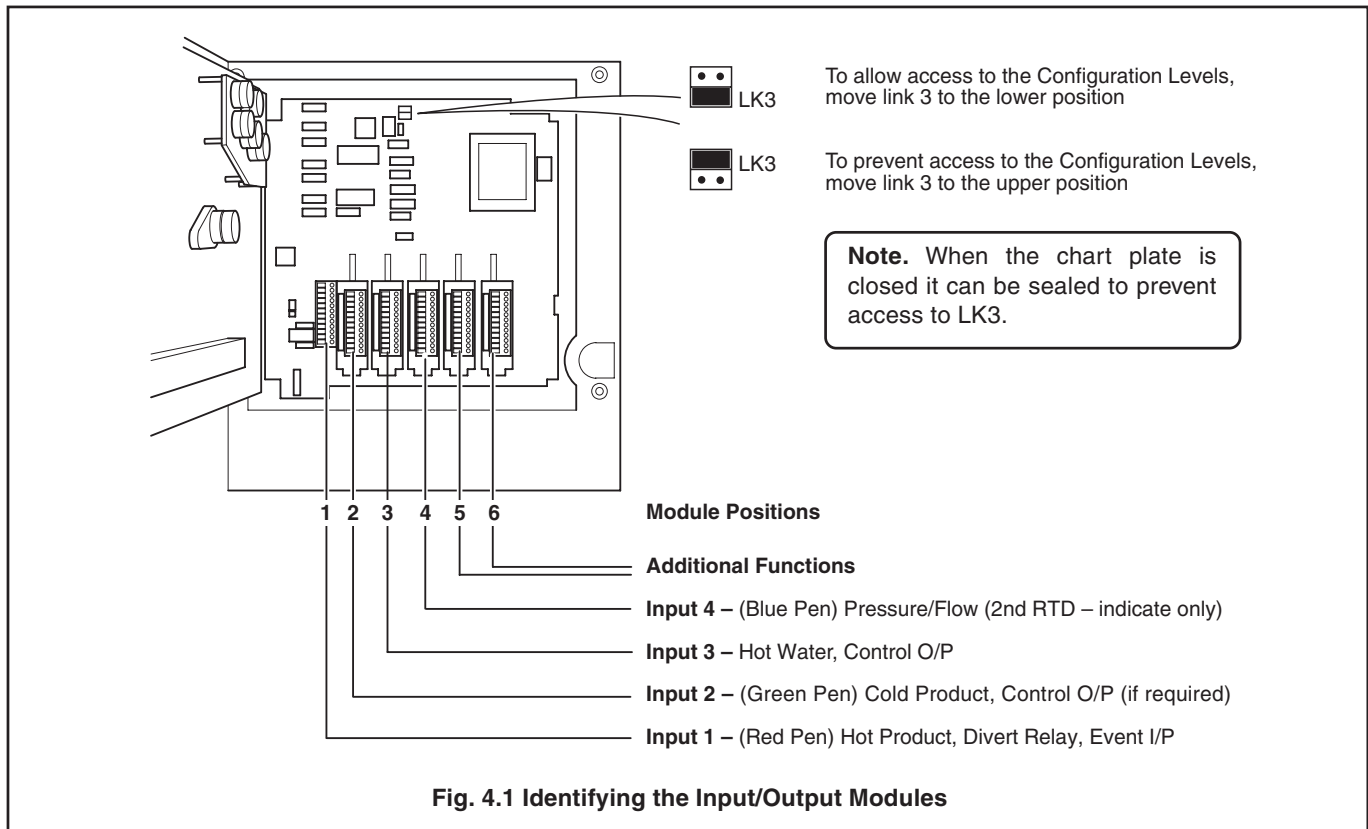

Fig. 4.1 Identifying the Input/Output Modules

4.2 Standard Connections – Fig. 4.2

Refer to *IM/C1900-INS*, Section 4.2 for input connections.

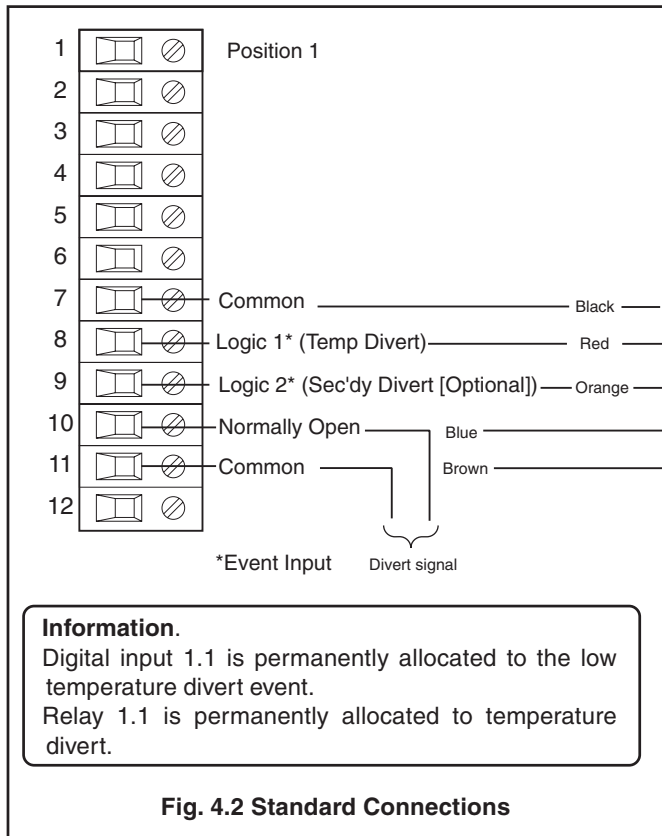

Fig. 4.2 Standard Connections

4.3 Dairy Relay Board Connections – Fig. 4.3

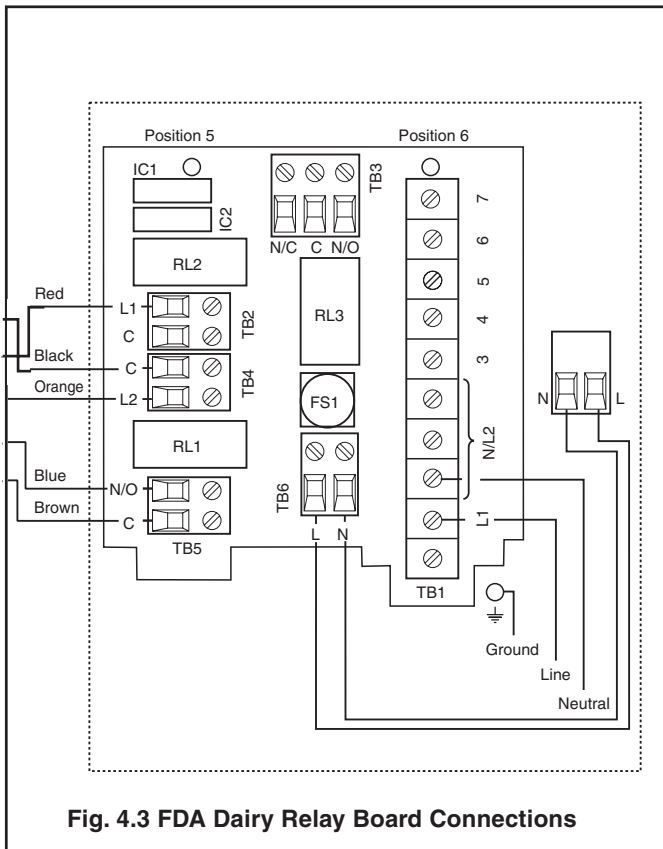

Fig. 4.3 FDA Dairy Relay Board Connections

5 OPERATION

5.1 Operating Sequence – Fig. 5.1

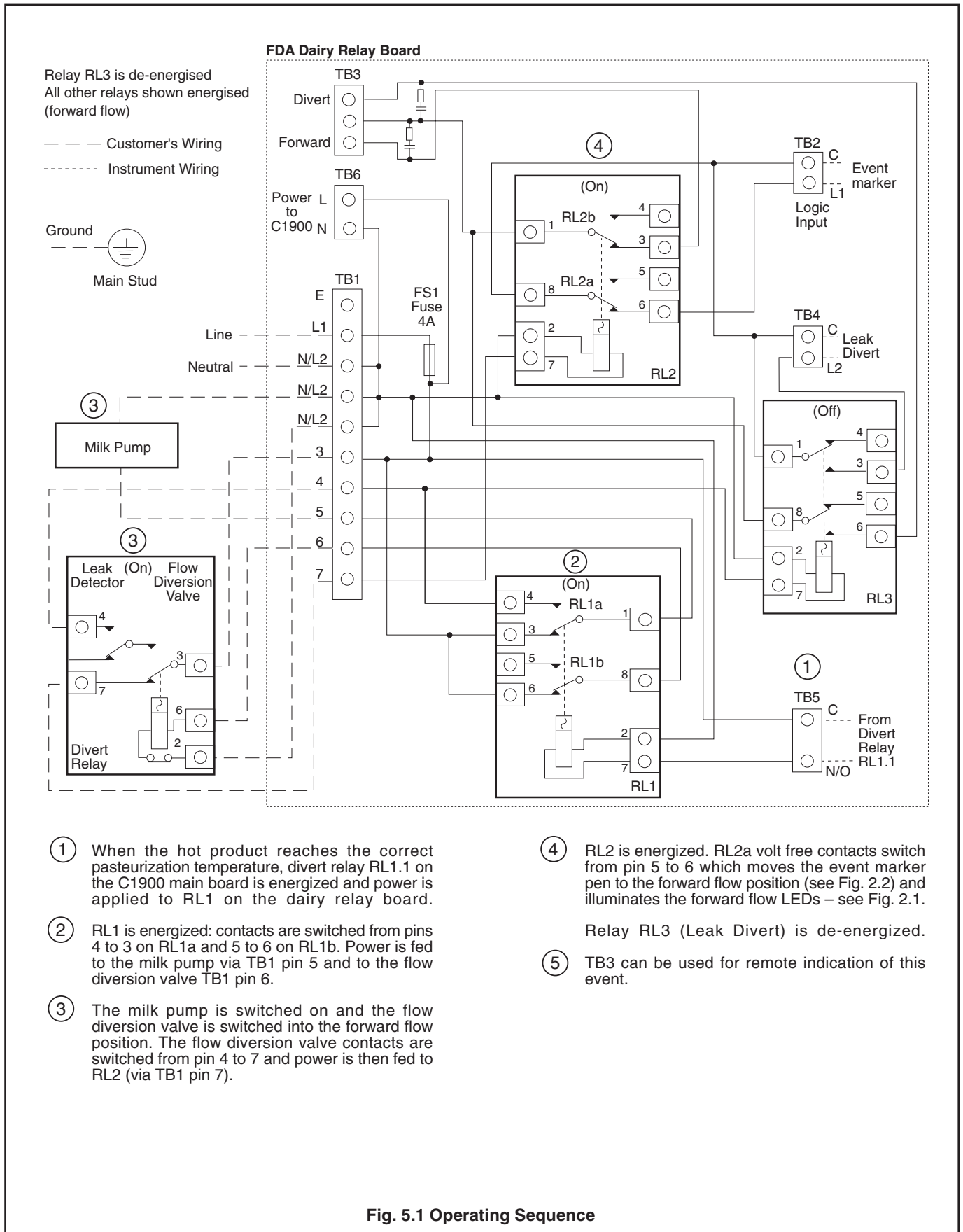
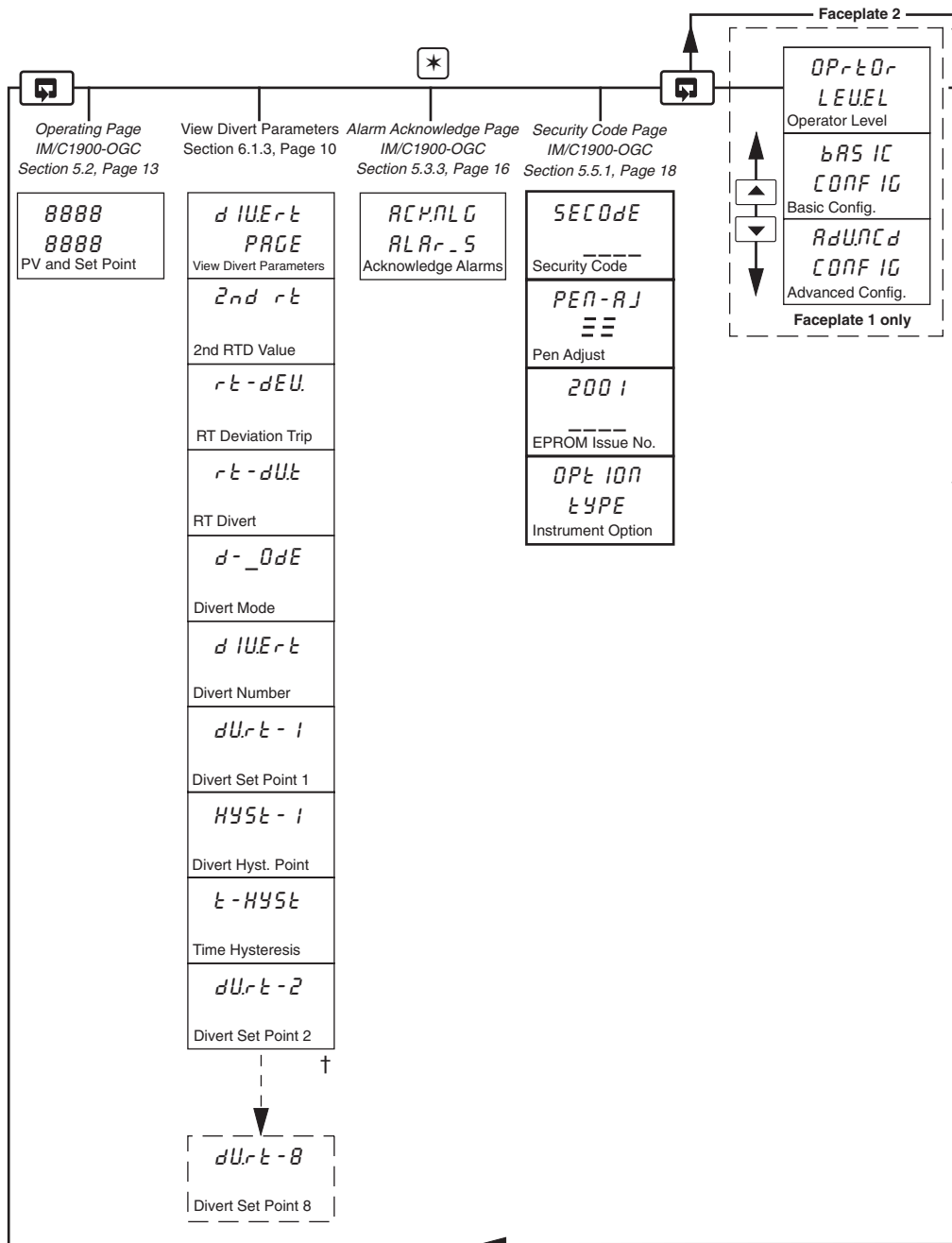

Fig. 5.1 Operating Sequence

6 OPERATING LEVEL

6.1 Operating Level – Fig. 6.1

Two additional frames (Pen Adjust and Instrument Option) and one additional page have been added to the Operating Level as shown on Figs. 6.1 and 6.2. For all other Operating Level frames, refer to *IM/C1900-OGC*.



† If multiple divert option is selected, divert temperatures (2 to 8) are shown here.

Note. The **Alarm Acknowledgement** page is only displayed if an alarm is present.

Fig. 6.1 Operating Level (Dairy/Pasteurizer Faceplate) Model 1951

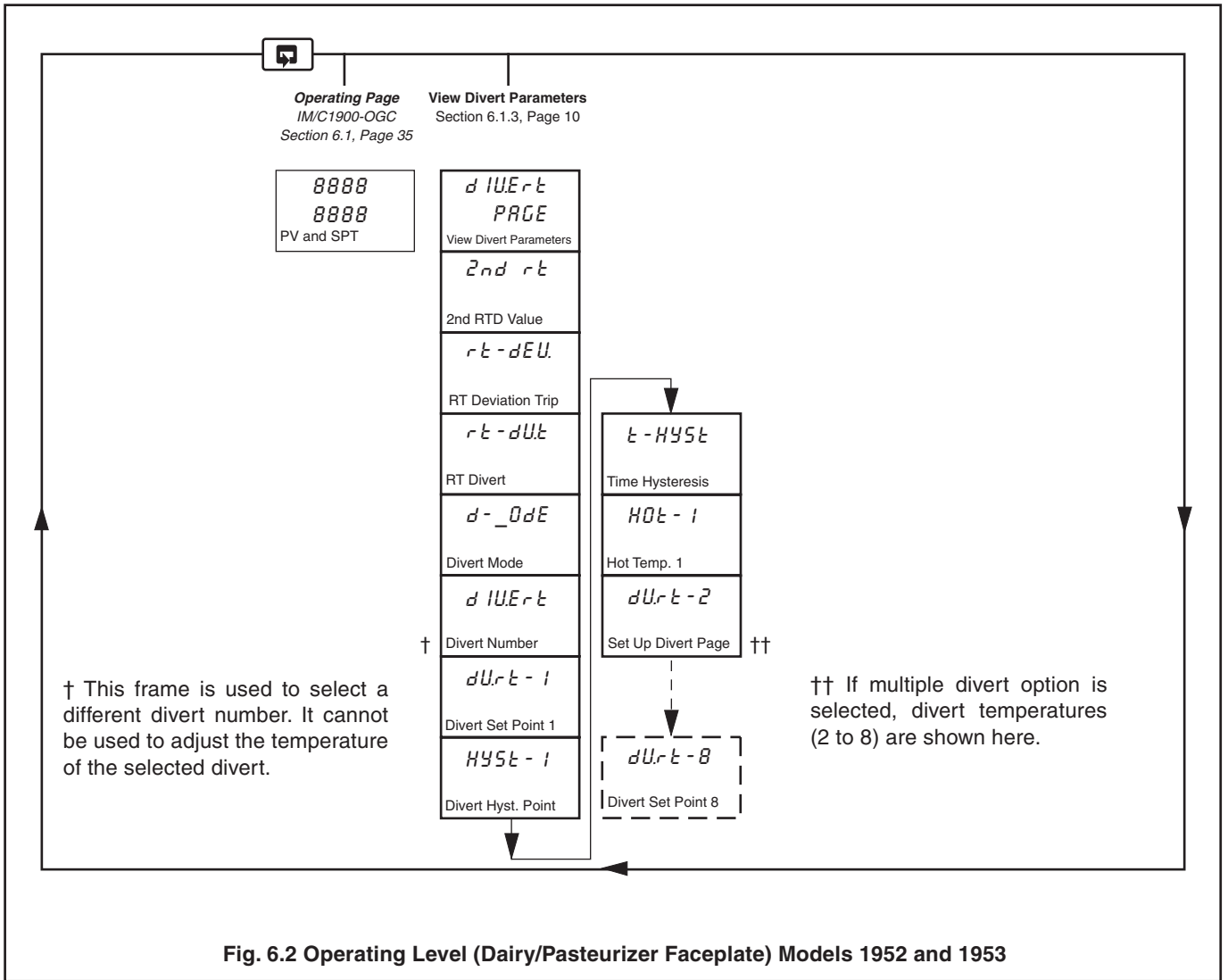

6.1.1 Pen Adjustment Frame

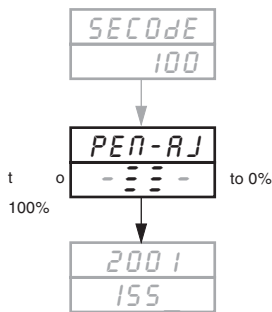

(example security code)

Pen Adjust

Allows micrometer adjustments of the hot product (red) pen (using the ▲ and ▼ keys) to be made when checking against an indicating thermometer.

The direction of pen movement is indicated by additional center bars on the bargraph.

- ▲ key adjusts pens towards 100% (left center bar)
- ▼ key adjusts pens towards 0% (right center bar)

6.1.2 Instrument Option Frame

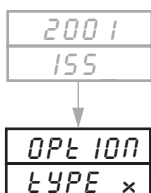

Instrument Option

Shows instrument type G, H or J (model G = 1951, model H = 1952, model J = 1953).

...6 OPERATING LEVEL

6.1.3 View Divert Parameters

The View Divert Parameters Page displays parameters and messages set up in the Divert Page shown in Section 7.1.5. These parameters can be monitored but not modified at this level.

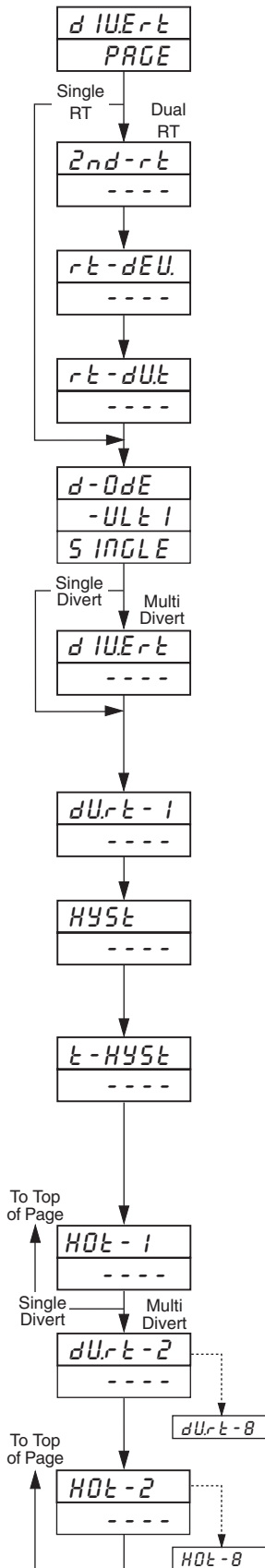

Page Header – Divert Page

Second RT Value

If dual RTD values are selected, the temperature value for the second RTD is displayed.

RT Deviation Trip Value

Displays the deviation level (1st – 2nd RTD value) set for difference condition.

If $(1^{\text{st}} - 2^{\text{nd}} \text{RTD}) > \text{rt-dEU}$, then deviation trip condition is true.

RT Divert

Shows if diversion enabled for the above trip condition.

Divert Mode

Displays the divert mode configured (multi or single):

- ULt 1 – Up to eight divert set points,
- S INGLE – One divert set point.

Divert Number

Displays the number of the divert set point(s): 1, 2, 3, 4, 5, 6, 7 or 8 (used with associated **Divert Set Point and Hot Water Set Temperature** displays) – models 1952 and 1953 only.

Caution. Do not change divert numbers during a process (only before or after).

Divert Set Point 1

Displays the temperature set for divert set point 1.

Divert Hysteresis Point

Displays the hysteresis value set (in engineering units) common to all set points.

Note. Only activated on values above the divert set point temperature.

Time Hysteresis

Displays the time hysteresis value set between 0 and 9999 seconds (common to all set points).

Note. If product temperature reaches the set point value, forward flow is initiated $t-hysl$ seconds after reaching this value. If the temperature drops below the setting in the **Divert Set Point** display, flow is diverted immediately.

Hot Water Set Temperature 1 (Models 1952 and 1953 only)

Displays the hot water control temperature set point for divert set point 1, used in conjunction with associated divert number 1.

Divert Set Points 2 to 8

Displays the temperature for divert set points (from 2 to 8 as selected) used in conjunction with associated divert numbers 2 to 8.

Hot Water Set Temperature 2 (Models 1952 and 1953 only)

Displays the hot water control temperature set point for divert set points (from 2 to 8 as selected) used in conjunction with associated divert numbers 2 to 8.

7 BASIC CONFIGURATION LEVEL

7.1 Basic Configuration Level – Fig. 7.1

The general content of the Basic Configuration Level is detailed in *IM/C1900-PGC, Section 3*.

Any changes or additions to Basic Configuration Level frames are detailed in this Sections 7.1.1 to 7.1.11 of this manual.

An additional (Divert) page is also included in this level as shown in Fig. 7.1.

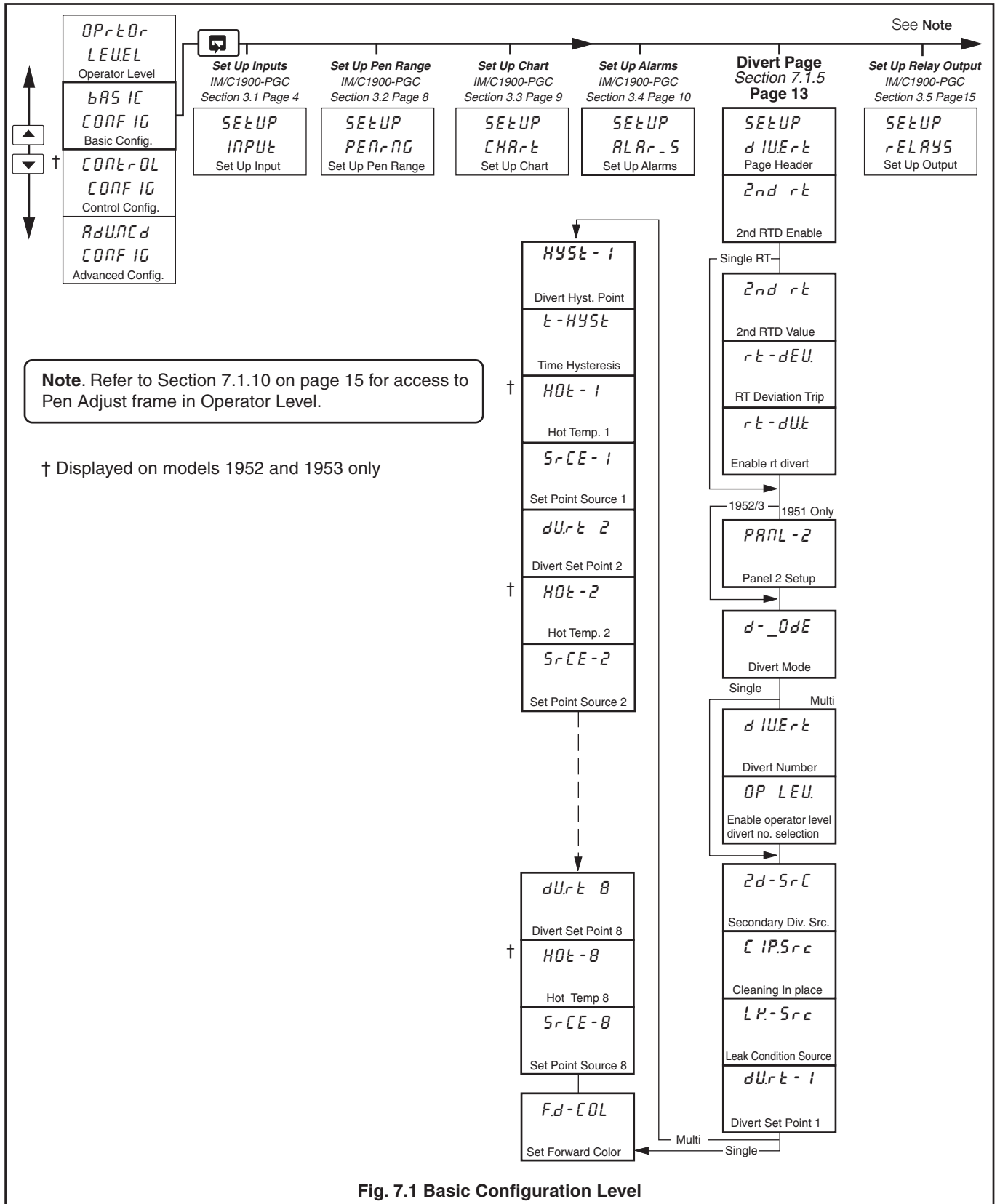

Fig. 7.1 Basic Configuration Level

...7 BASIC CONFIGURATION LEVEL

7.1.1 Set Up Input

As detailed in *IM/C1900-PGC, Section 3.1, page 4*.

7.1.2 Set Up Pen Range

As detailed in *IM/C1900-PGC, Section 3.2, page 8* with the following changes:

SELECT
PEN 3
PEN 2
PEN 1
NONE

Select Pen

Blue Pen (3) is only displayed on model 1953.

True Time Event Pen is not displayed on any C1900 Dairy/Pasteurization model.

7.1.3 Set Up Chart

As detailed in *IM/C1900-PGC, Section 3.3, page 9* with the following additional Lift Source frame.

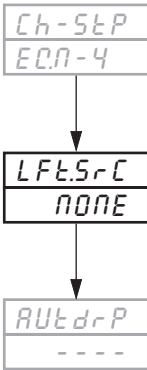

Lift Source

The pen lift source can be any digital (level triggered) input source.

Press the  switch to lift the pens from the chart.

Inputs are still tracked but are not traced until the switch is pressed again to drop the pen back onto the chart.

7.1.4 Set Up Alarms

As detailed in *IM/C1900-PGC, Section 3.4, page 10*.

7.1.5 Divert Page

For correct fail-safe operation of the event pen, the polarity of digital input position 1 must be set to **positive** – see *IM/C1900-INS*. Switches connected to input position 1 must be short-circuited in the de-activated state.

When all inputs are de-activated, the 'forward flow' pen position is selected – see Table 7.1.

With the 'temperature divert input' (D1.1) open circuit, the event pen moves to the 'diverted flow, low temperature position'.

The CIP position (input D2.1) is only selected if the process temperature is also above the divert temperature and the divert signal to D1.1 is inhibited at the pasteuriser control panel.

The secondary divert input (D1.2) overrides the CIP, Forward Flow or Divert Flow inputs. The secondary divert signal can also be assigned to any other digital input position. This enables an alternative polarity to be set if the input is open circuit in the non-active state.

Event Pen Position	Required Digital Input States		
	Positive polarity: O/C = Input active		
	1.1	1.2	2.1
Forward Flow	S/C	S/C	S/C
Divert	O/C	S/C	S/C
Clean In Place	S/C	S/C	O/C
Secondary Divert	S/C or O/C	O/C	S/C or O/C

Table 7.1 Event Pen Position

...7.1.5 Divert Page

Note.

2nd RT and RT Deviation – the hot product temperature can be measured by a single or dual RTD. For the dual RTD, the primary input is always the one displayed as ‘Hot Product’.

The secondary RTD enables a self-check facility which can be used to maintain the integrity of primary and secondary resistance thermometer devices. Any imbalance between the first and second RTD greater than the trip level entered in the appropriate scroll automatically causes the flow to divert, regardless of the primary temperature measurement.

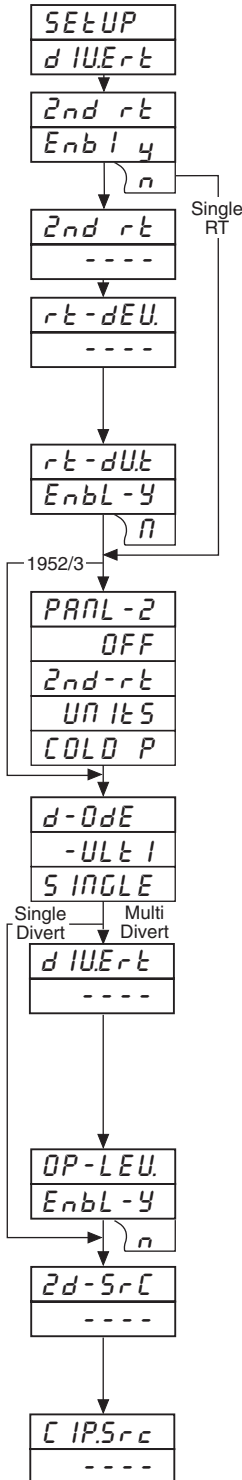

Page Header – Set Up Divert Page

Second RT Enable

Enables dual RTD selection (provided the auxiliary input module is fitted).

Second RT Value

If dual RTD values have been selected, the temperature value for the second RTD is displayed.

RT Deviation Trip Value

Set the deviation level (1st – 2nd RTD value) required for difference condition. If (1st – 2nd RTD) > rt-dEU. the deviation trip condition is true.

RT Divert Enable

Enables diversion if the above condition is true.

Panel 2 (Record Faceplate) Set Up (displayed with model 1951 only – see fig. 2.3)

	Panel 2 Upper Display	Panel 2 Lower Display
OFF	Blank	Blank
2nd-rt	Second RT value	(1st RT – 2nd RT) value
UNITS	Hot product units	Divert temp. units
COLD.P	Cold product value	Blank

Divert Mode

The instrument can be configured to operate in one of two divert modes:

- _ULE 1 – Up to eight divert set points can be set.
- SINGLE – One divert set point can be set.

Divert Number

Select the divert setting required:

- 1, 2, 3, 4, 5, 6, 7 or 8 (used with associated Divert Set Point, Hot Water Set Temperature and Set Point Source displays).

Caution. Do not change divert numbers during a process (only before or after).

Operator Level (Enable Divert Number Selection)

Allows the divert number to be selected at Operator level.

Secondary Divert Alarm Source

Diverts event pen on any assigned digital condition.

Cleaning in Place

Set digital source for CIP event.

continued on next page...

...7 BASIC CONFIGURATION LEVEL

...7.1.5 Divert Page

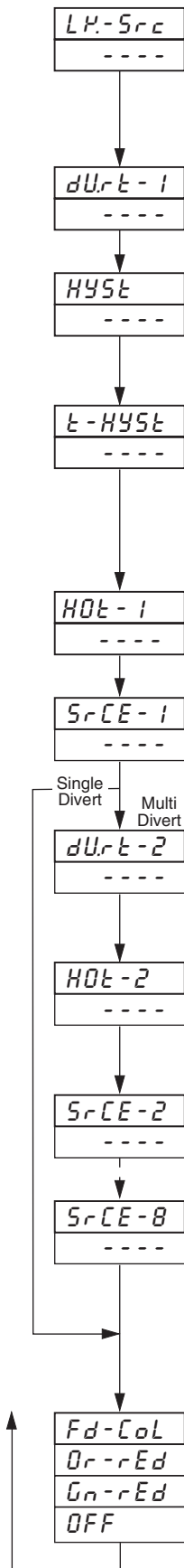

Leak Condition Source (see Section 2.1, Fig. 2.1)

If a leak detect source is used, a leak detect output from that device can be transmitted to a C1900 Dairy Pasteurization unit. This allows the unit to divert flow via a second back-up/divert valve fitted in series with the first valve. If a divert event is required, digital input 1.2 must be used and *Ld-Src* must also be set to digital input 1.2.

Divert Set Point 1

Set the temperature for divert set point 1.

Divert Hysteresis Point

Set the hysteresis value required in engineering units (common to all set points).

Note. Only activated on values above the divert set point temperature.

Time Hysteresis

Set the time hysteresis value required between 0 and 9999 seconds (common to all set points).

Note. If product temperature reaches the set point value, forward flow is initiated t-hyst seconds after reaching that value. If the temperature drops below the setting in the **Divert Set Point** display, flow is diverted immediately.

Hot Water Set Temperature 1 (Model 1952 and 1953 only)

Set the hot water control temperature set point for divert set point 1, used in conjunction with associated divert number 1.

Set Point Source 1

Select the digital source to engage set point 1.

Divert Set Point 2

Set the temperature for the required divert set point 2, used in conjunction with associated divert number 2.

Hot Water Set Temperature 2 (Models 1952 and 1953 only)

Set the hot water control temperature set point for divert set point 2, used in conjunction with associated divert number 2.

Set Point Source 2

Select the digital source to engage set point 2.

Repeat the above procedure for additional Divert Points, Hot Water and Set Point Sources.

Up to 8 individual Divert Points can be set, each has an associated Hot Water and Set Point Source.

Note. The Hot Water Set Temperature facility is not available with model 1951.

Forward/Divert Indicator Color

Select LED indicator color to display forward and diverted flow.

<i>Or-rEd</i>	=	Orange forward flow, red divert flow
<i>Gn-rEd</i>	=	Green forward flow, red divert flow
<i>OFF</i>	=	No forward or divert flow indication

Note. The standard setting is green for forward flow, red for diverted flow.

7.1.6 Set Up Relay Output

As detailed in *IM/C1900-PGC, Section 3.5*, with the following changes:

Information. Relays can be energized by alarms, logic equation results, digital inputs, control and set point modes, totalizer wrap signal (totalizer option on model 1953 only).

Select Relay Output

No setup is allowed for relay 1.1 which is assigned to the divert alarm, with polarity set as negative. All relays remain de-energized for 10 seconds after instrument reset. This holds the instrument in failsafe divert mode.

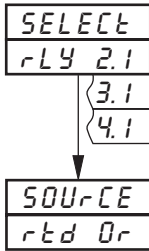

Select Relay
Select required relay.

Relay Source
Select the source required to activate the selected relay – refer to *IM/C1900, Section 3.5, Table 3.1* for source description.
rtd Or (rtd overrange) is an additional source to those listed in Table 3.1.

7.1.7 Digital Inputs

As detailed in *IM/C1900-PGC, Section 3.8*.

7.1.8 Set Up Digital Output

As detailed in *IM/C1900-PGC, Section 3.6*.

7.1.9 Set Up Analogue Output

As detailed in *IM/C1900-PGC, Section 3.7*.

7.1.10 Access Page

As detailed in *IM/C1900-PGC, Section 3.9* with the following additional frame which is displayed after the **Tune Password 2** frame:

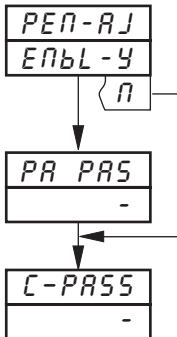

Pen Adjust
Password frame to allow micrometer adjustment of the red pen.
N If the password is not enabled (N selected), the micrometer adjustment value is not applied to position of the red pen.
Y If the password is enabled (Y selected), pen adjustment is included.
Select micrometer adjust code.

7.1.11 Scale Adjust

As detailed in *IM/C1900-PGC, Section 3.10* with the following changes:



Select Process Variable

Note. No adjustment is available for the True Time Event Pen.

Model	Hot P (I/P1) Pen 1 (Red)	Cold P (I/P2) Pen 2 (Green)	Hot W (I/P3) No Pen	2 nd RTD (Aux) No Pen
1951	PV1	PV2	–	PV3
1952	PV3	PV2	PV1	PV4
1953	PV3	PV2	PV1	PV4

8 ADVANCED CONFIGURATION LEVEL

8.1 Advanced Configuration Level – Fig. 8.1

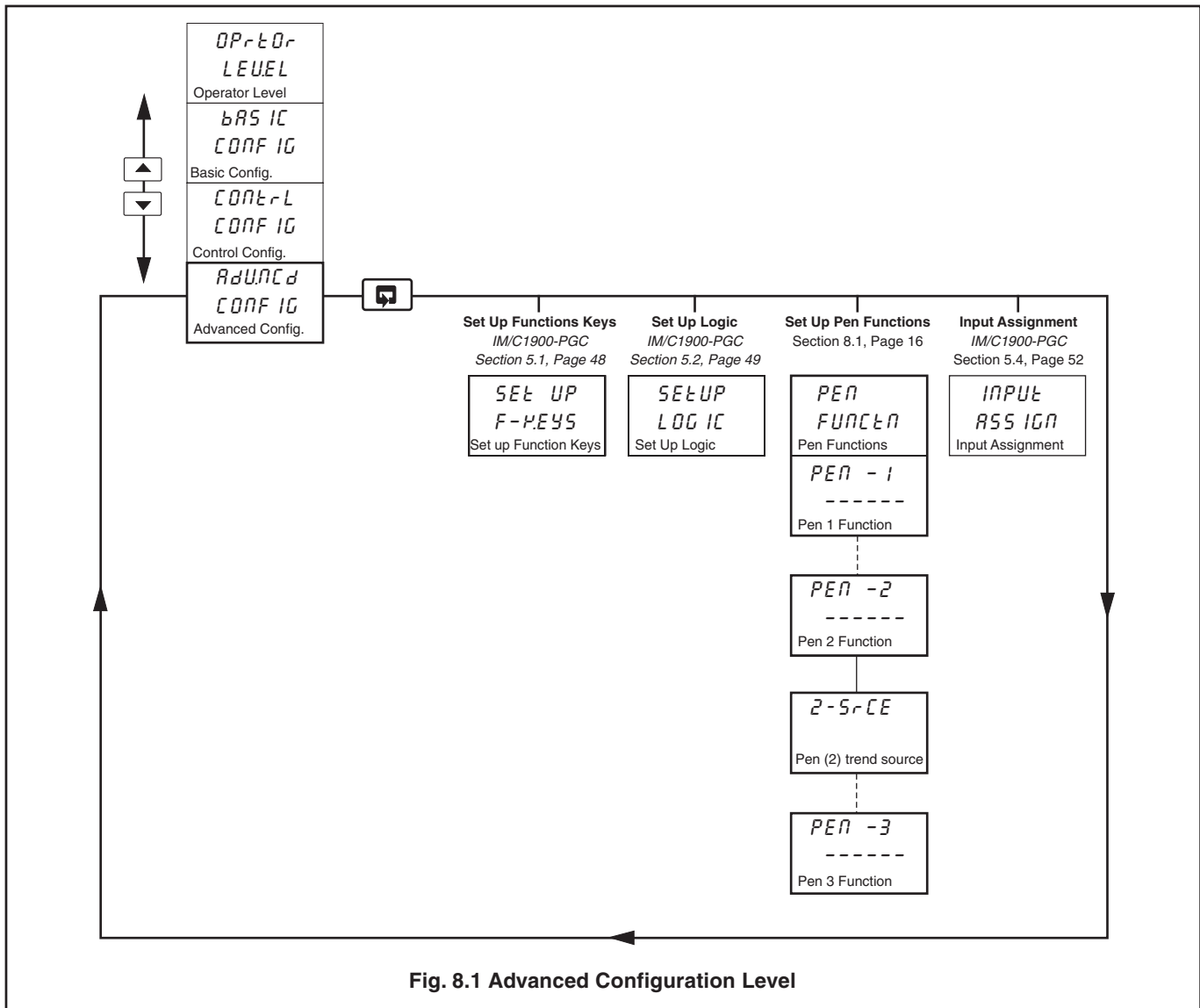
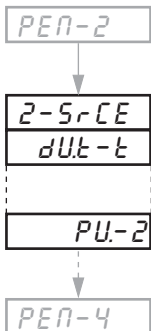

Fig. 8.1 Advanced Configuration Level

8.1.1 Set Up Pen Functions

As detailed in *IM/C1900-PGC, Section 5.3* with the following additional Pen Trend source frame.



Pen 2 Trend Source

Select the analog source signal for the Green Pen (2).

Usually this is selected as divert trip temperature setting (*dUt-t*), although it can be selected as cold product (*PU-2*).

Sales



Service



Software



—

ABB Limited

Measurement & Analytics

Howard Road, St. Neots
Cambridgeshire, PE19 8EU
UK

Tel: +44 (0)870 600 6122

Fax: +44 (0)1480 217 948

Email: enquiries.mp.uk@gb.abb.com

ABB Inc.

Measurement & Analytics

125 E County Line Road
Warminster, PA 18974
USA

Tel: +1 215 674 6000

Fax: +1 215 674 7183

abb.com/measurement



—

We reserve the right to make technical changes or modify the contents of this document without prior notice. With regard to purchase orders, the agreed particulars shall prevail. ABB does not accept any responsibility whatsoever for potential errors or possible lack of information in this document.

We reserve all rights in this document and in the subject matter and illustrations contained therein. Any reproduction, disclosure to third parties or utilization of its contents – in whole or in parts – is forbidden without prior written consent of ABB.

© ABB 2018