



Anderson Instrument Co., Inc.
156 Auriesville Rd.
Fultonville, NY 12072

Phone: 518-922-5315 or 800-833-0081
Fax: 518-922-8997 or 800-726-6733

ANDERSON-NEGELE

Startup Guide

“DTG” Digital Temperature Gauge

Style FH0, FH1, FH2, or FH5

SPECIFICATIONS

Compliance: 3-A, NEMA 4X, IP-66
Product Contact Surface: Fitting & Probe: 316L SS
Non-Product Contact Surface: Housing - 304 SS
Lens - Polysulfone
Process Temp. Range: 0 to 300°F (-18 to 150°C)
Units: Deg F and Deg C; field selectable
Resolution: 0.1°F or °C
Accuracy: +/- .75°F (+/-0.4°C)
Ambient Operating Limits: 40 to 140°F (4.4 to 60°C)
Ambient Temp. Stability: Better than 0.1°C per 10°C ambient shift
Storage Temp.: 32 to 140°F (0 to 65°C)

Display: LCD: 4 digit main display, 6 digit secondary; 0.9" high contrast LCD
Error Warning: LCD flashing
Power: Two "AA" 3.6VDC Thionyl Chloride Lithium (Style 0,1,5); Customer supplied 9-30 VDC(Style 2)
Style 0,1,5: 12 months typical
Style 2: external power
Battery Life: 10 to 60 Hz, 2g
Vibration: 2 year
Warranty: 3 seconds
Display Update: Via onboard switches; single point offset adjust
Calibration Adjustment: R_a max = 32 micro inches
Surface Finish:

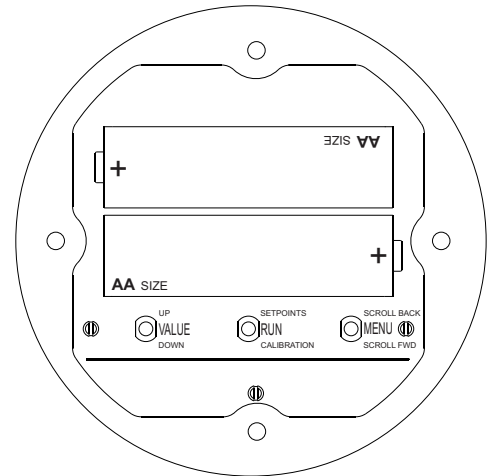
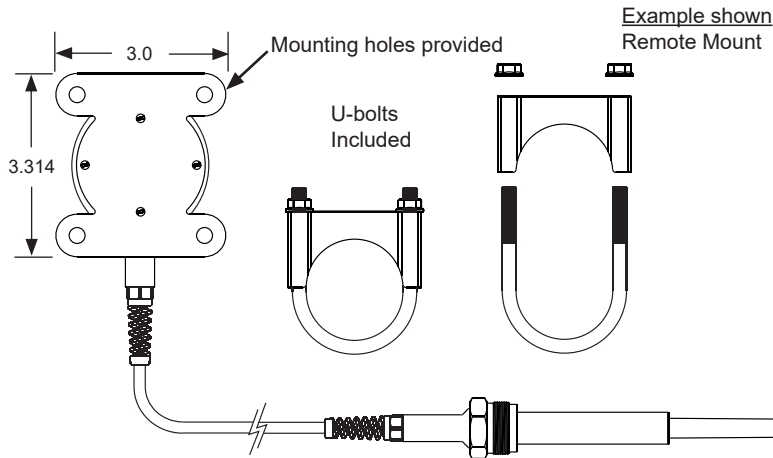

NOTE:
Remove back plate to access Value, Run, and Menu keys used for programming.

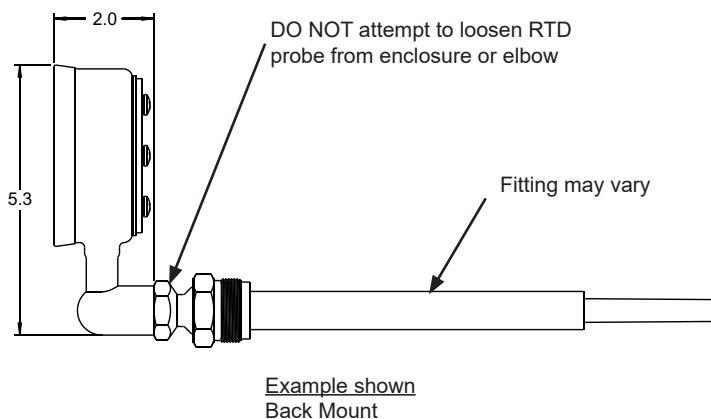

Battery Replacement

Three segment battery indicator is used to monitor battery life. When low threshold is reached, final indicator bar will blink to signal required battery change. All program and calibration data is retained during low voltage as well as power down - NO REPROGRAMMING REQUIRED.

Thionyl Chloride Lithium 3.6VDC "AA" cells REQUIRED for operation. If standard Alkaline 1.5VDC cells installed, following message displayed:

USE 3.6 LITH BATT

Manufacturer: Xeno (Model XL060F)
Anderson Part #: 62071A0001
(Note - Units with optional AC switch module do not require batteries)

NOTE: When removing batteries, wait a minimum of (2) two minutes before re-installing.

DTG Model "FH1" - Secondary RTD Wiring

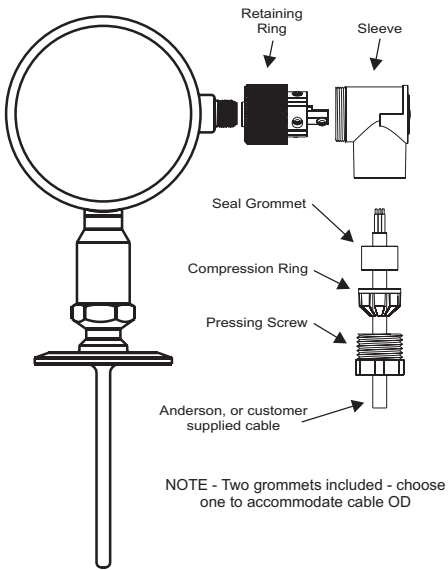

NOTE - Two grommets included - choose one to accommodate cable OD

Wiring Diagram - 3 WIRE RTD

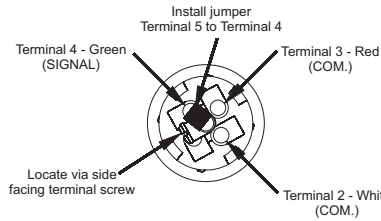

(NOTE: Anderson color codes indicated)

Wiring Diagram - 4 WIRE RTD

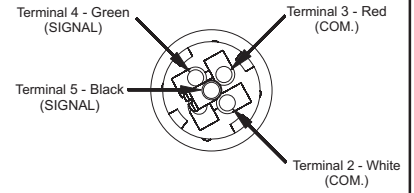

(NOTE: Anderson color codes indicated)

DTG Model "FH2" - Switch Wiring

Wiring Diagram - Utilizing on-board switching only

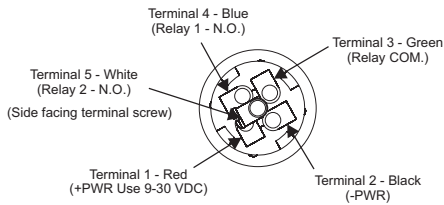

(NOTE: Anderson color codes indicated)

External DC supply must be used in order to utilize on-board switching

9-30 VDC, 250 mA typical external power required to energize relays

N.O. Relay contacts rated for 1 amp max @ 24 VDC

If customer supplied, cable requirements are:
5 conductor, stranded, 18-24 AWG.
0.16" to 0.31" Cable Sheath O.D.

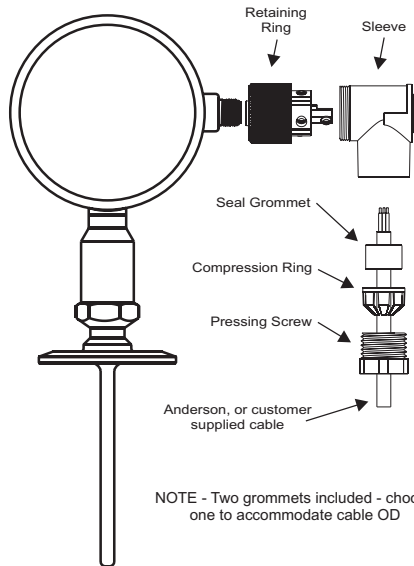

NOTE - Two grommets included - choose one to accommodate cable OD

Wiring Diagram - Utilizing "Optional" external AC powered switch module

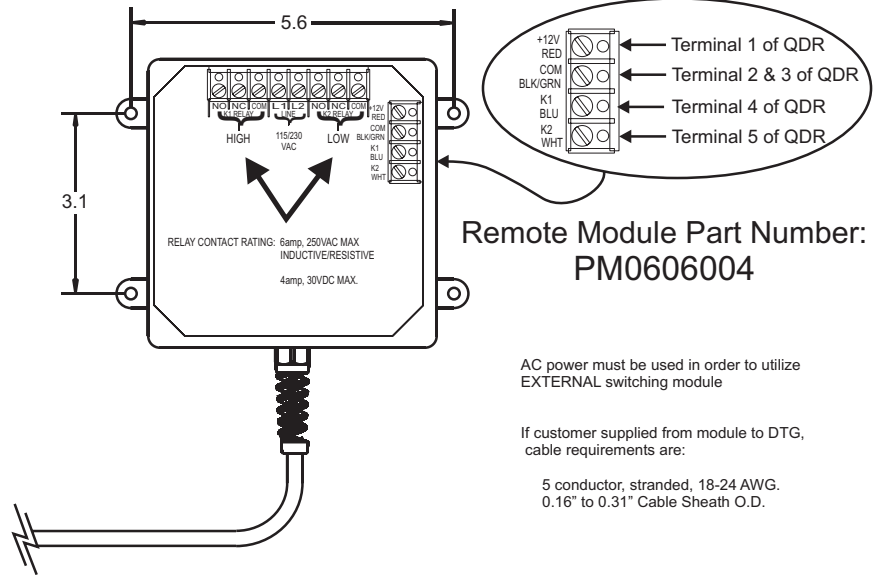

Remote Module Part Number:
PM0606004

AC power must be used in order to utilize EXTERNAL switching module

If customer supplied from module to DTG, cable requirements are:

5 conductor, stranded, 18-24 AWG.
0.16" to 0.31" Cable Sheath O.D.



Change Offset Value

The "Offset Value" function is used to apply a linear offset factor to the device. If your DTG shows a repeatable discrepancy (less than 1 degree) throughout the test range, this function may be used to remove the differential.

Example: Reference reads 32.0°F and DTG reads 32.3°F
 Reference reads 150.0°F and DTG reads 150.3°F
 Reference reads 212.0°F and DTG reads 212.3°F







"Offset Value" of "-0.3°F" programmed will remove discrepancy

CAUTION: Be sure to use only an NIST traceable reference thermometer that is known accurate, and within it's specified calibration period.

1.	Flip Run switch to the down position.	
2.	Press Menu switch up and release once to go to <i>Offset</i> screen.	
3.	Use Value switch to set <i>Offset</i> from 0.0 to +/-5.0.	
4.	Flip Run switch to the middle position.	



Restore Factory Settings

The "Restore Factory Settings" function will return the DTG to the factory shipped calibration.

1.	Flip Run switch to the down position.	
2.	Press Menu switch down and release once to go to <i>Unit</i> screen.	
3.	Press Menu switch down and release once to go to <i>Dampening Factor</i> screen.	
4.	Press Menu switch down and release once to go to <i>Decimal Position</i> screen.	
5.	Press Menu switch down and release once to go to <i>Factory Reset</i> screen.	
6.	Hold Value switch up for 5 seconds to restore factory settings.	
7.	Flip Run switch to middle position.	





Change Unit of Measure

The DTG may be programmed to read in either Degrees F or Degrees C. When changing from one mode to another, any "User Calibration" points are converted automatically to their respective unit of measure – no additional programming is required.

1.	Flip Run switch to the down position.	
2.	Press Menu switch down and release once to go to <i>Unit</i> screen.	
3.	Use Value switch to alternate between °F and °C.	
4.	Flip Run switch to the middle position.	

Change Decimal Position





The DTG is capable of displaying to the nearest WHOLE DEGREE, or with the addition of a decimal point, to the NEAREST TENTH degree. Modifying this parameter requires no additional programming changes to "User Calibration" points.

1.	Flip Run switch to the down position.	
2.	Press Menu switch down and release once to go to <i>Unit</i> screen.	
3.	Press Menu switch down and release once to go to <i>Dampening Factor</i> screen.	
4.	Press Menu switch down and release once to go to <i>Decimal Position</i> screen.	
5.	Use Value switch to alternate select decimal position.	
6.	Flip Run switch to middle position.	

WHOLE DEGREE display will ROUND DOWN to previous whole number.
 Example: Process = 181.9 °F Display = 181°F

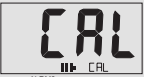
Change Dampening Factor

The "Dampening Factor" is used as a means to slow down the reaction rate of the unit. Under most circumstances, this value should be set to "0." If a process has very erratic temperature shifts, and the display fluctuates, introduction of a small dampening factor may smooth display.

1.	Flip Run switch to the down position.	
2.	Press Menu switch down and release once to go to <i>Unit</i> screen.	
3.	Press Menu switch down and release once to go to <i>Dampening Factor</i> screen.	
4.	Use Value switch to set <i>Dampening Factor</i> from 0.0 to 10.0.	
5.	Flip Run switch to middle position.	

Change Alarm 1 Setpoint

The DTG has alarm capability to signal with flashing text when a temperature is too high or too low.

1.	Flip Run switch to the up position.	
2.	Use the Value switch to set the Setpoint.	
3.	The value of Alarm 1 Setpoint is saved after the Run switch is returned to the middle position.	

Change Alarm 2 Setpoint

The DTG has alarm capability to signal with flashing text when a temperature is too high or too low.

1.	Flip Run switch to the up position.	
2.	Press the Menu switch down and release once to go to <i>Alarm 1 Action</i> screen.	
3.	Press the Menu switch down and release once to go to <i>Alarm 1 Hysteresis</i> screen.	
4.	Press the Menu switch down and release once to go to <i>Alarm 2 Setpoint</i> screen.	
5.	Use the Value switch to set the Setpoint.	
6.	The value of Alarm 2 Setpoint is saved after the Run switch is returned to the middle position.	

Change Alarm 2 Action

The "Alarm Action" can be set to HI to activate alarm if temperature goes above a max temp, LO if temperature goes below a min temp, or OFF.

1.	Flip Run switch to the up position.	
2.	Press the Menu switch down and release once to go to <i>Alarm 1 Action</i> screen.	
3.	Press the Menu switch down and release once to go to <i>Alarm 1 Hysteresis</i> screen.	
4.	Press the Menu switch down and release once to go to <i>Alarm 2 Setpoint</i> screen.	
5.	Press the Menu switch down and release once to go to <i>Alarm 2 Action</i> screen.	
6.	Use the Value switch to set the Action to either HI, LO or OFF.	
7.	The value of Alarm 2 Action is saved after the Run switch is returned to the middle position.	

Change Alarm 1 Action

The "Alarm Action" can be set to HI to activate alarm if temperature goes above a max temp, LO if temperature goes below a min temp, or OFF.

1.	Flip Run switch to the up position.	
2.	Press the Menu switch down and release once to go to <i>Alarm 1 Action</i> screen.	
3.	Use the Value switch to set the Action to either HI, LO or OFF.	
4.	The value of Alarm 1 Action is saved after the Run switch is returned to the middle position.	

Change Alarm 1 Hysteresis

The "Hysteresis" function delays the alarm by a set value. Example: Alarm is set to a HI value of 76. The hysteresis value is set to 2. Alarm will activate when temp reaches 78.

1.	Flip Run switch to the up position.	
2.	Press the Menu switch down and release once to go to <i>Alarm 1 Action</i> screen.	
3.	Press the Menu switch down and release once to go to <i>Alarm 1 Hysteresis</i> screen.	
4.	Use the Value switch to set the Hysteresis.	
5.	The value of Alarm 1 Hysteresis is saved after the Run switch is returned to the middle position.	

Change Alarm 2 Hysteresis

The "Hysteresis" function delays the alarm by a set value. Example: Alarm is set to a HI value of 76. The hysteresis value is set to 2. Alarm will activate when temp reaches 78.

1.	Flip Run switch to the up position.	
2.	Press the Menu switch down and release once to go to <i>Alarm 1 Action</i> screen.	
3.	Press the Menu switch down and release once to go to <i>Alarm 1 Hysteresis</i> screen.	
4.	Press the Menu switch down and release once to go to <i>Alarm 2 Setpoint</i> screen.	
5.	Press the Menu switch down and release once to go to <i>Alarm 2 Action</i> screen.	
6.	Press the Menu switch down and release once to go to <i>Alarm 2 Hysteresis</i> screen.	
7.	Use the Value switch to set the Hysteresis.	
8.	The value of Alarm 2 Hysteresis is saved after the Run switch is returned to the middle position.	